

# PSTC Test Methods

Test Methods for Pressure Sensitive Adhesive Tapes, 15th Edition

## Contents

### **Adhesion Test Methods**

- [PSTC-101](#) International Standard for Peel Adhesion of Pressure Sensitive Tape
- [PSTC-4](#) Relative Performance of Release Coatings
- [PSTC-5](#) Quick Stick of Pressure Sensitive Tapes
- [PSTC-6](#) Tack Rolling Ball
- [PSTC-107](#) International Standard for Shear Adhesion of Pressure Sensitive Tape
- [PSTC-8](#) Unwind Force of Pressure Sensitive Tape
- [PSTC-9](#) Accelerated Aging of Pressure Sensitive Tape
- [PSTC-11](#) Adherence to Linerboard of Pressure Sensitive Tapes at Low Temperature
- [PSTC-13](#) High Speed Unwind Adhesion of Pressure Sensitive Tapes
- [PSTC-14](#) Adhesion of Pressure Sensitive Tapes to Fiberboard at 90° Angle and Constant Stress
- [PSTC-15](#) Determination of Adhesion to Release Coated Substrates: Wet Spread Method
- [PSTC-16](#) Loop Tack

### **Stain Resistance Test Methods**

- [PSTC-21](#) Stain Test for Finishes
- [PSTC-22](#) Latent Staining of Surface Finishes

### **Miscellaneous Test Methods**

- [PSTC-131](#) International Breaking Strength and Elongation of Pressure Sensitive Tapes
- [PSTC-133](#) International Thickness (Caliper) of Pressure Sensitive Tapes
- [PSTC-34](#) Water Vapor Transmission of Pressure Sensitive Tapes
- [PSTC-35](#) Water Penetration Rate of Pressure Sensitive Tapes
- [PSTC-38](#) Tear Resistance of Pressure Sensitive Tapes
- [PSTC-39](#) Tear Resistance of Plastic Film Tapes

### **Electrical Tape Test Methods**

- [PSTC-50](#) Shear Strength After Solvent Immersion of Electrical Grade Tapes
- [PSTC-51](#) Dielectric Breakdown of Electrical Grade Tapes
- [PSTC-53](#) Thermosetting Properties of Electrical Grade Tapes
- [PSTC-54](#) Flagging of Electrical Grade Tapes
- [PSTC-55](#) Oil Resistance of Electrical Grade Tapes
- [PSTC-56](#) Resistance to Penetration at Elevated Temperatures of Electrical Grade Tapes
- [PSTC-57](#) Flammability of Electrical Grade Tapes
- [PSTC-58](#) Insulation Resistance at High Humidity (Indirect Electrolytic Corrosion)

### **Width and Length Test Method**

- [PSTC-71](#) Guide for Width and Length of Pressure Sensitive Tapes

<a href="#">Appendix A</a>	Standard Conditions
<a href="#">Appendix B</a>	Test Equipment
<a href="#">Appendix C</a>	Cleaning Test Surfaces
<a href="#">Appendix D</a>	Preparation for Testing
<a href="#">Appendix E</a>	Quality Assurance of Pressure Sensitive Tapes
<a href="#">Appendix F</a>	Metric-English Conversion
<a href="#">Glossary of Terms Used in the Pressure Sensitive Tape Industry</a>	

Call Letters	PSTC 101
Date of Issuance	10/00
Revised	10/03
Revised	05/07

## Peel Adhesion of Pressure Sensitive Tape

### 1. SCOPE

1.1 These methods cover the measurement of the peel adhesion of pressure sensitive tapes. Peel adhesion is the force required to remove a pressure sensitive tape from a test panel or its own backing at a controlled angle and at a standard rate and condition.

1.1.1 Test Method A gives a measure of the adherence, when peeled at 180° angle at 5 mm/sec, to a standard steel panel or other surface of interest for a single-coated tape.

1.1.2 Test Method B gives a measure of the adherence to the backing of a single-coated tape.

1.1.3 Test Method C gives a measure of adherence of double-coated tape to a standard steel panel or other surface of interest.

1.1.4 Test Method D gives a measure of adherence of the release liner to the adhesive of either single or double-coated tape.

1.1.5 Test Method E gives a measure of adherence of an adhesive transfer tape to a standard steel panel or other surface of interest.

1.1.6 Test Method F gives a measure of adherence, when peeled at 90° angle, to a standard steel panel or other surface of interest for a single-coated tape.

1.2 These methods provide a means of assessing the uniformity of the adhesion of a given type of pressure sensitive adhesive tape. The assessment may be within a roll of tape, between rolls, or between production lots.

1.3 Variations in the tape backing and adhesive affect the response. Therefore, these methods cannot be used to pinpoint the specific cause(s) of non-uniformity.

1.4 These test methods may not be appropriate to test tapes having either relatively stiff backings, stiff liners, or backing showing high stretch at low forces. These characteristics will result in a high variability for the test response which is not a true indication of the real nature of the adhesive bond.

Afera: Association des Fabricants Européens de Rubans Auto-Adhésives (Association of European Tape Manufacturers)

ASTM: American Society for Testing and Materials (USA)

EN: European Norm (Europe)

PSTC: Pressure Sensitive Tape Council (North America)

## **2. REFERENCED DOCUMENTS**

### **2.1 ASTM Standards**

A 666 Specification for Austenitic Stainless Steel, Sheet, Strip, Plate and Flat Bar.

D 3330/D 3330M Test Method for Peel Adhesion of Pressure-Sensitive Tape.

D 3715/D 3715M Practice for Quality Assurance of Pressure-Sensitive Tapes.

D 5750 Guide for Width and Length of Pressure-Sensitive Tape.

### **2.2 Afera**

2.2.1 Afera 5001 Self adhesive tapes - Measurement of peel adhesion from stainless steel or from its own backing.

### **2.3 EN**

2.3.1 EN 1939 Self adhesive tapes - Determination of peel adhesion properties.

## **3. SUMMARY OF TEST METHOD**

3.1 Test Method A - Single-coated tapes, peel adhesion at 180° angle - A strip of tape is applied to a standard test panel (or other surface of interest) with controlled pressure. The tape is peeled from the panel at 180° angle at a specified rate, during which time the force required to effect peel is measured.

3.2 Test Method B - Adhesion to backing, single-coated tapes - A strip of the tape under test is applied to a rigid panel. A strip of the tape under test is applied to the backing of the first strip and tested for peel adhesion as described in method A.

### **3.3 Test Method C - Double-coated tapes**

3.3.1 Face side adhesion - A strip of double coated tape is adhered to a stainless steel panel (or other surface of interest), liner side up. The liner is removed and the exposed adhesive covered with a strip of 0.025 mm thick polyester film. The resulting tape is then tested as described in method A.

3.3.2 Liner side adhesion - The face side adhesive of a strip of tape is adhered to a 0.025 mm thick polyester film. The liner is removed and the strip is applied adhesive down, to a stainless steel panel (or other surface of interest). Testing is conducted as described in method A.

3.4 Test Method D - Adhesion to liner - A strip of tape is adhered to a standard steel test panel with the liner side up. The liner is peeled from the adhesive in the same manner as in peeling a strip of single coated tape from a standard panel as described in method A.

### **3.5 Test Method E - Adhesion of adhesive transfer tapes**

3.5.1 Face side - A strip of the transfer tape is adhered to a standard panel (or other surface of interest), liner side up. The liner is removed and the exposed adhesive covered with a strip of 0.025 mm thick polyester film to form a film backed strip of tape. The adhesion is measured as described in method A.

3.5.2 Liner side - The face side adhesive of a strip of transfer tape is applied to a strip of 0.025 mm thick polyester film. The liner is removed and the strip is applied, adhesive down, to a stainless steel panel (or other surface of interest). Testing is described in method A.

3.6 Test Method F - Single-coated tapes, 90° peel - A strip of tape is applied to a standard test panel (or other surface of interest) with controlled pressure. The tape is peeled from the panel at a 90° angle at a specified rate, during which time the force required to effect peel is measured.

#### 4. SIGNIFICANCE AND USE

4.1 These test methods are tools for quality assurance use. Given specific pressure sensitive tape and a requirement in terms of the minimum or maximum peel value expected for this tape, the data from the test can be used in conjunction with acceptance criteria.

4.2 Test Methods A, B, C, E, or F can show the relative bond strength of a given tape to one or more surfaces (material and texture) as compared to the standard stainless steel panel. Substitution of representative samples of materials in question for the standard steel panel would suffice to do this.

4.3 Test Methods A, B, C, E, or F cannot be used to compare two pressure sensitive tapes of the same type but of different manufacture for their ability to adhere to a surface. This is because the measured peel force is not normalized for a fixed area of stress. The area under stress varies with backing stiffness and adhesive rheology (firmness). Two different tapes seldom agree in these properties.

4.4 Test Method D can show the amount of force required to remove a liner that covers the adhesive side of a tape at a specified peel rate. The force will be different at other peel rates.

4.5 These test methods may not provide design information as there is usually no direct relationship between peel adhesion and any functional requirement.

#### 5. APPARATUS - See Appendix B

5.1 Specimen cutter - The specimen cutter shall hold two single-edge razor blades in parallel planes, a precise distance apart, to form a cutter of exact specimens widths. Two cutters, 12 and 24 mm cutting width, shall be available or appropriate alternates which will not cause edge damage.<sup>1</sup>

Note - The 12 mm cutter shall consist of a 12 mm thick by 200 mm length aluminum bar stock 12 mm wide. The edges for about 125 mm from one end shall be slightly rounded to form a handle. The width of the bar for 75 mm from the opposite end shall be narrowed to exactly 12 mm minus the thickness of a single razor blade (one of two used as cutting edges). The razor blades shall be held in position using side plates. The end of the cutter shall be cut away at a 45° angle to expose the cutting edge at one end of the blades. The edges shall be separated by 12 + 0.10 mm. The 24 mm cutter shall follow the same description except the bar stock shall be 24 mm and shall be narrowed exactly 24 mm minus the thickness of a single razor blade.

5.2 Dispensing system, for solvents, such as a wash bottle.

5.3 Panel - A 50 by 125 mm no less than 1.1 mm thick stainless steel 302 or 304 in accordance with Specification ASTM A 666 having a bright annealed finish. The surface roughness height shall be 50 ± 25 nm arithmetical average deviation from the mean line. Panels showing stains, discoloration, or many scratches are not acceptable. New panels should be cleaned prior to use as described in 10.1, except with ten washes of the final solvent. Between uses, the panel test surface shall be protected from scratches and contamination, and the panels stored at conditions described in 9.

5.4 Roller, mechanically or hand operated (See Figures 1 & 2).

5.4.1 A steel roller 85 ± 2.5 mm in diameter and 45 ± 1.5 mm in width, covered with rubber approximately 6 mm in thickness, having a Shore scale A durometer hardness of 80 ± 5. The surface shall be a true cylinder void of any convex or concave deviations. The mass of the roller shall be 2040 ± 45 g.

5.4.2 No part of the apparatus shall increase the pressure of the roller during use. The roller shall move either mechanically or by hand at the rate of 10 ± 0.5 mm/s. A mechanical roll down is recommended for referee purposes.

<sup>1</sup> These widths correspond to the primary metric (SI) units described in ASTM D 5750. These so called “modular metric” units are used throughout the world except for Europe. If it is desirable to test slightly different widths (e.g., 25 mm) of specimens per 8.1, this should be noted per 17.1.7 and calculations per 16.1 must also account for the difference.

5.5 Adhesion tester (See Figure 3) - A constant-rate-of-extension (CRE) tension tester shall be used. It is proposed to use an electronic machine taking at least one reading per mm tape peeled. The tester shall have two clamps with centers in the same plane, parallel with the direction of the motion on the same plane, parallel with the direction of the motion on the stressing clamp, and so aligned that they will hold the specimen wholly in the same plane; a means of moving the stressing clamp at a uniform rate of  $5.0 \pm 0.2$  mm/s and a device for recording load. The instrument shall be calibrated to an accuracy of 0.5% of full scale and the scale range used for any test shall be such that the mean test level falls within 20 to 80% of full scale.

5.6 Fixture, 90° peel, for method F (1.1.6). The fixture shown in Figure 4 is to be employed.

## 6. REAGENT MATERIALS

6.1 Purity of reagents - Reagent grade chemicals should be used in all tests. Other grades may be used, provided it is first ascertained that the reagent is of sufficiently high purity to permit its use without lessening accuracy of the determination.

6.2 Solvents:

6.2.1 Any of the following solvents may be used for cleaning:

6.2.1.1 Diacetone alcohol non-residual, technical grade or better.

6.2.1.2 Methanol (95%).

6.2.1.3 Methyl Ethyl Ketone (MEK)

6.2.1.4 n-Heptane

6.2.1.5 Acetone

6.2.2 For final cleaning, before each test, MEK or acetone shall be used.

6.2.3 Where toxicity and flammability requirements are paramount, a mixture of n-Heptane and a fluorinated hydrocarbon, such as refrigerant, may meet requirements.

6.3 Cleaning material, absorbent; surgical gauze, cotton, wool, or tissue. To be suitable, materials must be lint-free during use, absorbent, contain no additives that are soluble in the solvents listed in 6.2, and made exclusively from virgin materials.

## 7. SAMPLING

7.1 Sampling shall be in accordance with ASTM Practice D 3715/D 3715M.

7.2 It is common to test at least five specimens of a particular tape.

## 8. TEST SPECIMENS

8.1 The specimen shall be 24 mm wide. If different, refer to note after 10.2. A tolerance of  $\pm 0.5$  mm shall be allowed. The length shall be approximately 300 mm.

8.2 Discard at least three but no more than six outer wraps of tape from the sample roll before taking the specimens for testing.

8.3 Remove one specimen per sample roll for each test to be performed. Remove the specimen from a freely rotating roll at the rate of 500 to 750 mm/s. Where width or other factors causing a high adherence to backing makes it impossible to remove the specimen at the prescribed rate, remove it at a rate as close to 500 mm/s as possible.

8.4 When tape is wider than 24 mm, specimens of the widest specified width are to be cut from the center of a strip removed from the roll in accordance with 8.3.

8.5 Apply specimen shortly after unwinding (within 5 minutes).

## 9. CONDITIONING

9.1 Condition the sample rolls of tape in the standard conditions of  $23 \pm 1^\circ \text{C}$  and  $50 \pm 5\% \text{ RH}$ . Test at these conditions.

Note - Caution: The tester should know that, by prolonged handling, heat is transmitted to the stainless steel test panel. Therefore, during and after application of the adhesive tape to the test panel, the panel should be handled as little as possible.

## 10. TEST METHOD A - Single-Coated Tapes at $180^\circ$ Angle

10.1 Dispense one of the solvents listed in 6.2.1 onto the panel, wiping it to dryness with fresh absorbent cleaning material. Repeat for a total of three washes with this solvent. Final wipe shall be MEK or acetone. The panel should be allowed to dry for at least 10 minutes. Panels not used within 10 hours should be recleaned.

Note - Discard panels showing stains, discoloration, or many scratches. Avoid contacting panel surface with fingers. During storage, panels should be protected from damage or contamination.

10.2 Remove a 300 mm specimen of the tape to be tested, as described in 8.3. Fold 12 mm at one end, adhesive-to-adhesive to form a tab. Touch other end of the specimen to an end of the test panel. Hold the other end of the specimen so that it does not make contact with the panel but is positioned loosely above it, roll mechanically or by hand twice in each lengthwise direction, causing the roller to apply the tape to the panel. This prevents entrapment of air between the adhesive and the panel. Should this occur, discard the specimen.

Note - Where the width of the specimen is less than 24 mm, prior to applying test specimen, apply a strip or strips of the tape, to give an equivalent width of 24 mm for rolling purposes or use roller of appropriate weight to obtain a line pressure equal to  $2040 \text{ g} \pm 45 \text{ gm}$  for 24 mm width.

10.3 Individually prepare each specimen and test within 1 minute.

Note - Longer dwell time will give different results. Peel adhesion increases with dwell time at different rates for various tapes. A longer dwell time may be chosen purposely.

10.4 Double back the folded end of the tape at an angle of  $180^\circ$  and peel 24 mm of the tape from the panel. Clamp that end of the panel into the movable jaw of the adhesion testing machine and the free end of the tape into the other jaw. Operate the movable jaw at  $5.0 \pm 0.2 \text{ mm/s}$ . See Figure 5.

10.5 After the movable jaw is started in motion, disregard the values obtained while the first 24 mm of tape is mechanically peeled. Use the average force obtained during peeling of the next 48 mm as the adhesion value.

## 11. TEST METHOD B - Adhesion to Backing of Single-Coated Tapes

11.1 Apply a sample of the tape under test to a rigid panel such as the standard stainless steel panel. Roll firmly. Apply a second strip of the tape to the backing of the strip on the test panel as described in 10.2 taking care to align the edges of the second specimen with those of the strip in the test panel. Complete testing as described in 10.3, 10.4, and 10.5.

## 12. TEST METHOD C - Adhesion of Double-Coated Tape

12.1 Face side - Follow the procedure of 10.1 through 10.3, then remove the liner and superimpose on the test strip a strip of 0.025 mm thick polyester film, as wide or slightly wider than that of the double-coated tape. Apply this film in the manner of applying the double-coated test strip to the panel so that the roller makes the actual application of the film to the double-coated tape.

Note - The four passes of the roller in applying polyester film may be made using the hand roller. The rolling rate may be increased to 50 mm/s.

12.1.1 Continue in accordance with 10.4 and 10.5.

12.2 Liner side - Adhere the face side of the specimen to a strip of 0.025 mm thick polyester film in the manner described in 10.2 so that the roller makes actual application of the tape to the film. Trim the film to be as wide as or slightly wider than the tape. Remove the liner.

12.2.1 Continue in accordance with 10.1 through 10.5.

### **13. TEST METHOD D - Adhesion to Liner of Double-Coated and Single-Coated Tapes**

13.1 Double-coated tapes - Follow 10.1. Apply 125 mm of one end of the specimen with the adhesive side (face side) down, to the panel. Make four passes with the roller, twice in each direction at a rate of  $10 \pm 0.5$  mm/s. Separate the liner from the tape at the free end and cut away the free tape. Do not disturb the liner adhered to the tape on the panel.

13.1.1 Double back the liner and proceed in accordance with 10.4 and 10.5.

13.2 Single-coated tapes - Follow 10.1. Apply a strip of double-coated tape, as wide as the specimen, the full length of the panel. Remove the liner from the double-coated tape. Superimpose 125 mm of one end of the specimen, backing side down, against the double-coated tape on the panel. Make four passes with the roller, twice in each direction at a rate of  $10 \pm 0.5$  mm/s. Separate the liner from the tape at the free end and cut away the free tape. Do not disturb the liner adhered to the specimen on the panel.

13.2.1 Double back the liner and proceed in accordance with 10.4 and 10.5.

### **14. TEST METHOD E - Adhesion of Adhesive Transfer Tapes**

14.1 Face side - Follow procedure of 10.1 through 10.3, then remove the liner and superimpose on the test strip a strip of 0.025 mm thick polyester film, as wide or slightly wider than the adhesive transfer tape. Apply this film in the manner as 10.2 so that the roller makes the actual application of the film to the adhesive transfer tape. Proceed as described in 10.4 and 10.5.

14.2 Liner side - Apply to the face side of the adhesive transfer tape a strip of 0.025 mm thick polyester film. Make two passes of the roller using a hand roller of the same size. The roller rate may be increased to 50 mm/s. Remove the liner from the tape and apply to a standard test panel as described in 10.2 through 10.3. Proceed as described in 10.4 and 10.5.

Note - In spite of its apparent simplicity, the use of this method is rather delicate and involves the use of great care in following the procedure as written to give coherent and identical results between one laboratory and another as well as between one operator and another.

### **15. TEST METHOD F - Single-Coated Tapes at 90° Angle**

15.1 Prepare specimen for testing as described in 10.1 through 10.3.

15.2 Double back the folded end of the tape at a 90° angle and peel 25 mm of the tape from the panel. Place the panel into a fixture (see Figure 3) clamped to the moving jaw of the adhesion tester so that it will maintain a peeling angle at 90° during the peeling of the next 75 mm of tape and the free end of the tape into the other jaw (see Figure 4). Operate the moving jaw at  $5.0 \pm 0.2$  mm/s.

15.3 Proceed per 10.5.

### **16. CALCULATIONS**

16.1 If the observed pull value is not in Newtons, convert to Newtons per 10 mm by converting the pull value to Newtons and dividing by the width of the tape in mm and multiplying by 10.

### **17. REPORT**

17.1 The report shall include the following:

17.1.1 Statement that this test method was used and indicating any deviations from the method as written.

17.1.2 Identify the source of each roll of tape tested.

17.1.3 Anomalous behavior during testing (such as adhesive transfer or splitting).

17.1.4 Peel adhesion value in Newtons per 10 mm to the nearest 0.1 N/10 mm. Use actual specimen width in calculations.



17.1.5 Which test method was used - A, B, C, D, E, or F, and if C or E, whether face side or liner side.

17.1.6 Dwell time, if less or greater than the standard 1 minute.

17.1.7 Test specimen widths if different from 8.1.

17.1.8 Conditions of test if other than  $23 \pm 1^{\circ}\text{C}$  or  $50 \pm 5\% \text{ RH}$ .

## **18. KEYWORDS**

18.1 Pressure sensitive tape; peel adhesion at  $180^{\circ}$  angle; peel adhesion at  $90^{\circ}$  angle; adhesion to liner; adhesion to backing.

---

## **SUMMARY OF CHANGES**

- Added reference to Afera 5001 in section 2.2
- Added section 2.3
- Added section 7.2

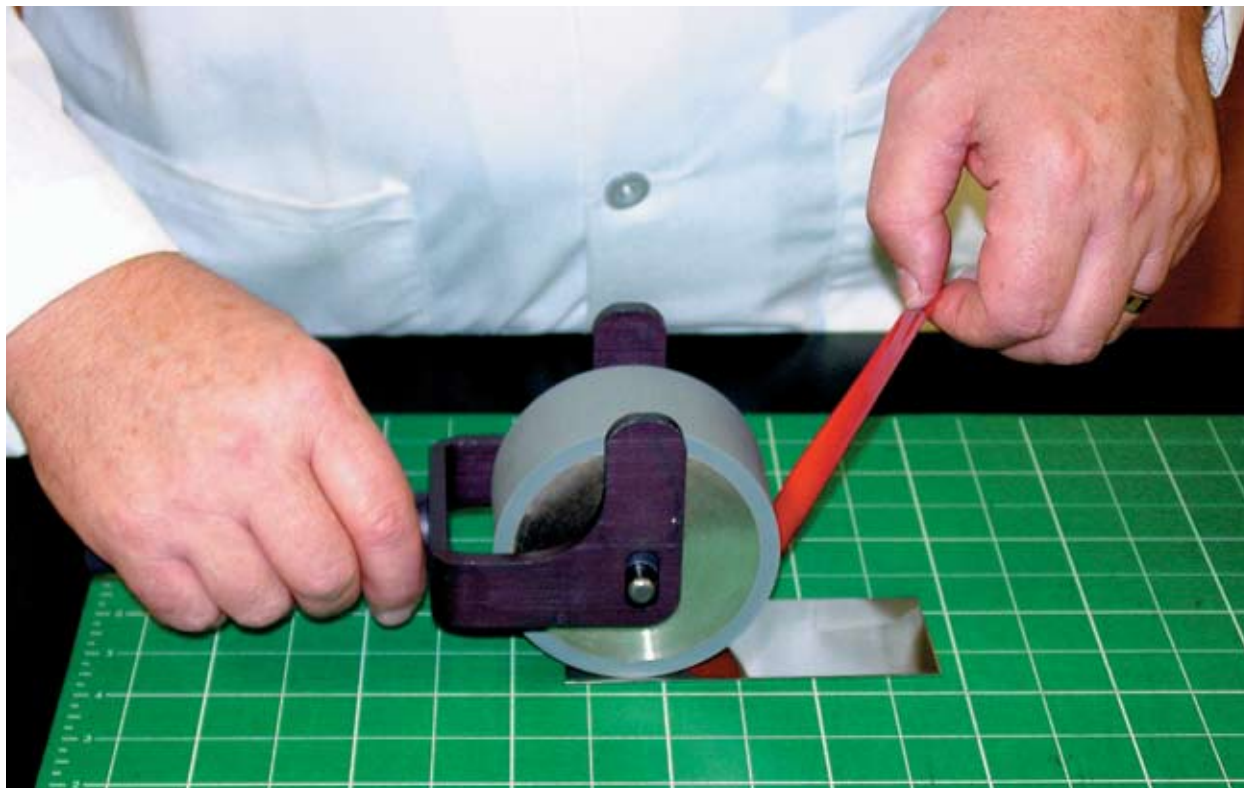

Figure 1. Hand operated roll down unit.



Figure 2. Mechanical roll down unit.



Figure 3. Tensile tester.

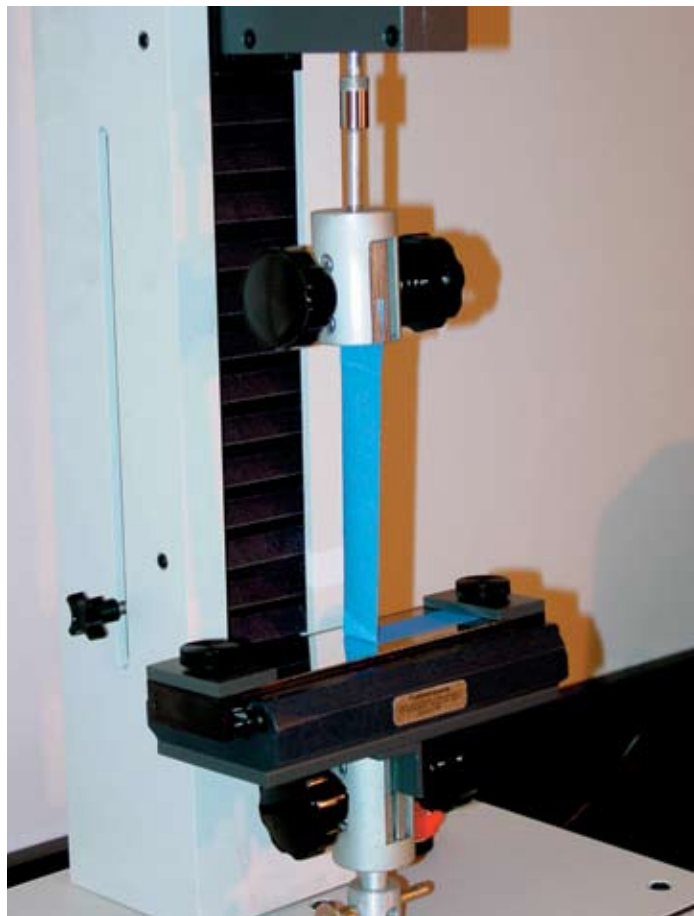

Figure 4. Tensile tester with 90 degree peel fixture.



Figure 5. Peel adhesion 180 degree peel.

Call Letters	PSTC 4
Date of Issuance	03/92
Revised	06/00
Revised	10/03

## Relative Performance of Release Coatings

### 1. DEFINITION

1.1 Release force is the measure of the force required to separate a unit width of pressure sensitive tape from a release liner at controlled angle and speed.

Subsequent adhesion is the force required to remove a unit width of pressure sensitive adhesive tape, which has been in contact with a release liner for a given period of time, from a standard test panel. The results of this test must be compared with the adhesion of the same tape which has not been in contact with the release liner to determine the degree of loss of adhesion.

### 2. SIGNIFICANCE

2.1 The following test is designed to compare two main properties of release coatings: 1) Ease of release (as “release force”), and (2) the effect that the coating has upon the adhesive properties of a pressure sensitive tape that has contacted the release surface (“subsequent adhesion”). It is designed for use as a tool in determining relative release levels and consistency.

### 3. TEST SPECIMEN

3.1 Pressure sensitive tape

3.1.1 For conditioning, selection, and test conditions, see Appendices A and D.

3.1.2 The test specimen shall be 24 mm (1”) wide and approximately 300 mm (12”) in length. A width tolerance of  $\pm 0.4$  mm (1/64”) shall be allowed. Select six specimens and number them 1 through 6.

3.2 Release coated liner

3.2.1 Condition specimens as described in Appendix A.

3.2.2 Randomly select from the liner material to be evaluated, sufficient liner material to provide three 48 mm x 150 mm (2” by 6”) specimens. Take care not to contaminate the side to be evaluated.

### 4. EQUIPMENT - See Appendix B

4.1 Tensile tester or adhesion/release tester.

4.2 Panels.

4.3 Roller, 2 kg (4 1/2 lb.), mechanically operated.

4.4 A roll of pressure sensitive tape, 24 mm (1”) wide, of a type mutually agreed upon between supplier and user. Because of the differences between tapes, caution should be used when comparing values obtained with different test tapes. Only rolls of tape having an adhesion of 17.4 to 21.2 Newton/100 mm or equivalent in other units should be used. The test tape should be specified when reporting results.

A Summary of Changes section appears at the end of this test method.

4.5 Two smooth metal pressure plates and weights sufficient to apply a uniform pressure of 1.724 kPa ( $1/4$  psi) on the test tape. Aluminum plates, 36 mm (1-1/2") by 144 mm (6") by 1.6 mm ( $1/16$ ") thick, can be used as the metal pressure plates. The plates must be flat and parallel to a tolerance of 0.025 mm (0.001"). A 24 mm (1") by 24 mm (1") by 96 mm (4") bar weighing 0.454 kg  $\pm$  0.045 kg (1  $\pm$  0.1 lbs.) placed lengthwise over the center of the pressure plate protecting the samples to be tested will yield the required 1.724 kPa ( $1/4$  psi).

4.6 An air circulating oven capable of maintaining a temperature of approximately 70°C (158°F) for 20 hours  $\pm$  1/2 hour.

## 5. TEST METHOD

5.1 Before each test, clean the panel per method in Appendix C.

5.2 Initial adhesion to steel - Using tape specimens marked 1, 3, and 5, touch one end of the specimen to the end of a test panel, hold the other end of the specimen so that it does not make contact with the panel but is positioned loosely above it. Roll the tape mechanically once in each lengthwise direction causing the roller to apply the tape to the panel. Take care not to entrap air between tape and panel. If such occurs, discard the specimen. Prepare all three specimens and allow to dwell for a minimum of 20 to a maximum of 25 minutes before testing for adhesion as described in 5.4. Report test results as initial adhesion to steel.

5.3 Adhesion to liner - Completely cover one side of three panels with liner by first covering the panel with a high adhesion double coated pressure sensitive tape. Firmly apply, wrinkle free and with no air entrapped, the liner specimen taking care not to touch or otherwise contaminate the exposed surface of the liner. This is best accomplished by touching one end of the liner to the tape-coated panel and using the roller to apply the liner to the panel. Trim excess length of liner at each end of the panel. Apply tape specimens 2, 4, and 6 to the liner-covered panels as described in 5.2. Place specimens in the oven and apply a panel and weight on top of the panel to provide 1.724 kPa ( $1/4$  psi) and allow to condition for 20 hours  $\pm$  1/2 hour. At the end of 20 hours  $\pm$  1/2 hour, remove the specimens from the oven, remove weight and top panel and condition as described in Appendix A until cooled to room temperature (approximately 1 hour).

### 5.4 Test procedure

5.4.1 Initial adhesion - Double back the free end of the tape at an angle of 180° and peel 24 mm (1") of the tape from the panel at the folded end. When using a tensile testing machine clamp the end of the panel from which the tape was removed into the moving jaw and the free end of the tape into the stationary jaw. The crosshead travel of the tensile testing machine is to be 300 mm/minute (12"/minute). After the moving jaw is started in motion, disregard the values obtained while the first 24 mm (1") of tape is mechanically peeled. Record the average adhesion obtained over the next 48 mm (2").

When using an adhesion/release tester, slide the panel under the panel clamps with the free end of the tape away from the force measuring instrument. Clamp the free end of the tape into the jaws and set the speed for 300 mm/minute (12"/minute). After the carriage starts moving, disregard the values obtained while the first 24 mm (1") of tape is mechanically peeled. Record the average adhesion obtained over the next 48 mm (2"). See Figure 1.

5.4.2 Adhesion to liner - Take the cooled specimens prepared as described in 5.3 and test as described in 5.4.1. Take care in removing the first inch to remove tape from the liner, not liner from the panel (see Figure 2). Report test values as adhesion to liner.

5.4.3 Subsequent adhesion to steel - After specimens 2, 4, and 6 have been removed from the liner as described in 5.4.2, apply each strip of tape to a clean steel panel as described in 5.2 and test as described in 5.4.1. Report values as subsequent adhesion to steel.

## 6. REPORT

6.1 Report all values in Newtons per 100 mm of width or other acceptable units. Metric-English system conversion factors are listed in Appendix F.

6.2 Report any effect the liner release coating may have on the tape as a percentage. The percentage subsequent adhesion is obtained by dividing the subsequent adhesion to steel value by the initial adhesion to steel value and multiplying by 100.

Another method for determining release characteristics is TAPPI Useful Method 502 and ASTM D 3330 Method C.

---

## SUMMARY OF CHANGES

No changes from the 14th edition.



Figure 1. Adhesion/release tester.



Figure 2. Adhesion to liner testing with tensile testing machine.



Call Letters	PSTC 5
Date of Issuance	02/59
Revised	05/59
Revised	11/70
Revised	08/85
Revised	08/89
Revised	06/00
Revised	10/03
Revised	05/07

## Quick Stick of Pressure Sensitive Tapes

### 1. DEFINITION

1.1 Quick stick is the property of a pressure sensitive tape that allows it to adhere to a surface under very slight pressure.

It is measured as the force resisting peeling of a unit width of tape at a 90° angle from a standard surface upon which it has been applied under no other pressure than the weight of the tape itself.

### 2. SIGNIFICANCE

2.1 Quick stick is a measure of a tape's ability to adhere with minimum pressure.

### 3. TEST SPECIMEN

3.1 For test specimen conditioning, selection, and test conditions, see Appendices A & D.

3.2 The test specimen shall be no greater than 24 mm (1") nor less than 12 mm (1/2") wide and approximately 300 to 375 mm (12 to 15") long. A width tolerance of  $\pm 0.04$  mm (1/64") shall be allowed.

### 4. EQUIPMENT - See Appendix B

4.1 Tensile tester.

4.2 Panel.

4.3 Fixture, quick stick test.

### 5. TEST METHOD

5.1 Clean panel as per method in Appendix C.

5.2 Hold the specimen parallel to and about 100 mm (4") above the cleaned test panel so that 125 mm (5") at one end is directly over the panel length. Touch the specimen end directly above the panel to the end of the panel nearest to it. Relax tension at the other end of specimen allowing specimen to drape smoothly onto panel. Assure that the tape is put on the panel without any foreign pressure and that the edges of the tape run parallel to the long edges of the panel (Figure 1).

5.3 Immediately insert the panel (the end of the panel with the free end of the test specimen first) into the fixture which has previously been secured in the lower jaw of the adhesion machine. Place the hook of the pulling cord on the far end of the panel if test jig is equipped accordingly (Figure 2). Fold over the adhesive surface of the free end to form a 24 mm (1") tab and clamp in the upper jaw of the adhesion tester. Make sure at this point that the free end is taut and the panel in the fixture is in a position so that the free end forms a right angle with the panel. Start crosshead or moveable jaw in motion immediately at a rate of 300 mm/min (12"/min). Disregard the values obtained while the first 24 mm (1") of tape is peeled mechanically. Use the average peel value obtained during the removal of the next 24 to 48 mm (1" to 2") as the quick stick value. Note: A trial run should be made prior to testing so that the length of the tape is taut and forms a right angle with the panel as in Figures 3 and 4. The test fixture is constructed so that the test panel will move at the same speed as the tensile tester movable jaw when the foregoing is done, thus maintaining a 90° angle of peel.

5.4 Repeat sections 5.1 through 5.3 four more times for a total of five replicate tests.

A Summary of Changes section appears at the end of this test method.

## 6. REPORT

6.1 Report the quick stick value(s) to the nearest 0.01 Newtons per centimeter (or to the nearest ounces per inch) of width.

---

### SUMMARY OF CHANGES

- Added section 5.4 to define recommended number of replicate tests.



Figure 1. Quick stick specimen preparation.



Figure 2. Inserting panel and hook attachment.

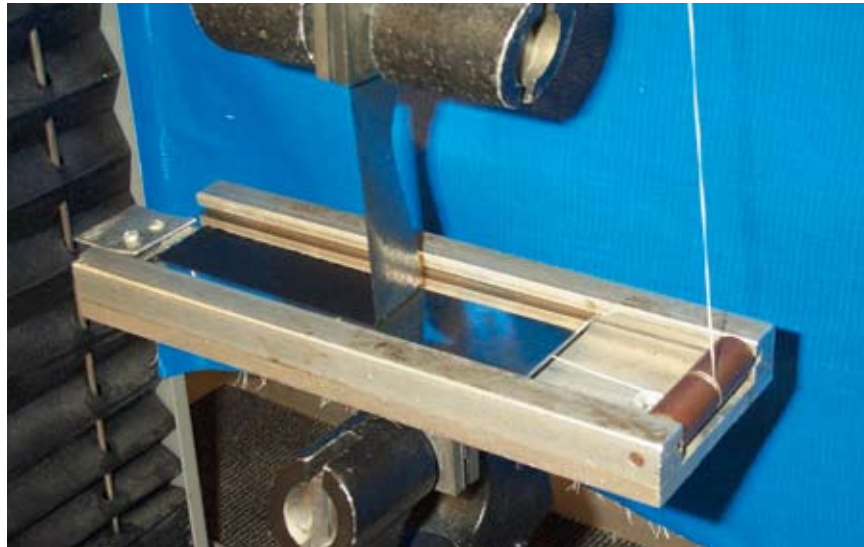

Figure 3. Test jig with pull cord.



Figure 4. Test jig with bearings.

Call Letters	PSTC-6
Date of Issuance	10/64
Revised	11/70
Revised	08/85
Revised	02/89
Revised	08/89
Revised	06/00
Revised	10/03

## Tack Rolling Ball

### 1. DEFINITION

1.1 The rolling ball tack test is one measure of the capacity of the adhesive to form a bond with the surface of another material upon brief contact under virtually no pressure.

### 2. SIGNIFICANCE

2.1 The rolling ball tack test is one method of attempting to quantify the ability of an adhesive to adhere quickly to another surface.

### 3. TEST SPECIMEN

3.1 For test specimen conditioning, selection, and test conditions, see Appendices A & D.

3.2 The test specimen shall be 24 mm (1") wide by approximately 375 mm (15") long.

### 4. EQUIPMENT - See Appendix B

4.1 Rolling ball test apparatus. See Figures 1 and 2.

4.2 A stainless steel ball, 11 mm (7/16") in diameter, such as a standard type ball bearing.

4.3 A working surface that is level, hard, and smooth, such as a table top, plate glass, etc.

### 5. TEST METHOD

5.1 Prior to testing each lot of tape, thoroughly clean the raceway surface with n-heptane, methyl ethyl ketone, isopropyl alcohol, or methyl alcohol. Prior to each roll of the ball, thoroughly clean the ball with the same solvent. Wipe with a lint-free, bleached, absorbent material to remove any remaining residue. After cleaning, do not touch the raceway or ball with fingers.

5.2 Ensure that the working surface is perfectly horizontal. Arrange the specimen to be tested, adhesive side up, on the working surface. Align the raceway of the incline with the tape under test so that at least 300 mm (12") of tape is exposed. The end of the specimen opposite the incline is to be held to the working surface with tape. Using clean dry tongs, place the ball on the upper side of the release pin. Release the ball and allow it to roll to a stop on the adhesive. Measure the distance from the point where the ball initially contacts the adhesive to where the ball stops (Figure 2).

### 6. REPORT

6.1 The average of the stopping distance measurements shall be reported in millimeters or in inches to the nearest 1/8". Five tests shall determine the average. A fresh strip of tape shall be used to begin each test, and the ball should be cleaned after each roll in accord with the cleansing procedure outlined in section 5.1.

Another method for measuring tack rolling ball is ASTM D 3121.

---

## SUMMARY OF CHANGES

No changes from the 14th edition.



Figure 1. Rolling ball apparatus components.



Figure 2. Rolling ball test apparatus and specimen showing distance of roll that is measured.

Call Letters	PSTC 107
Date of Issuance	10/00
Revised	10/03
Revised	05/07

## Shear Adhesion of Pressure Sensitive Tape

### 1. SCOPE

1.1 These procedures help determine the ability of a pressure sensitive tape to remain adhered under a constant load applied parallel to the surface of the tape and substrate. Shear adhesion (shear resistance) is the ability of a tape to resist static forces applied in the same plane as the backing.

1.1.1 Procedure A measures the shear adhesion when applied to a vertical standard steel panel.

1.1.2 Procedure B measures the shear adhesion when applied to a vertical panel covered with NIST (National Institute of Standards and Technology, USA) SRM 1810A standard fiberboard.

1.1.3 Procedure C measures the shear adhesion when applied to vertical panel covered with a fiberboard agreed upon by the buyer and seller.

1.1.4 Procedure D measures the shear adhesion of reinforced filament tape when applied to a horizontal standard steel panel.

1.1.5 Procedure E measures the shear adhesion of a filament-reinforced tape when applied to a horizontal panel covered with NIST SRM 1810A standard fiberboard.

1.1.6 Procedure F measures shear adhesion of a filament-reinforced tape when applied to a horizontal panel covered with a fiberboard agreed upon by the buyer and seller.

1.1.7 Procedure G is the same as Test Method A except the test is conducted at an elevated temperature and a 10-minute dwell time.

1.2 These procedures provide a means of assessing the uniformity of the adhesive of a given type of pressure sensitive tape (an example are tapes used for packaging applications). The assessment may be within a roll of tape, between rolls or production lots.

1.3 Variations in the tape backing and adhesive affect the results, therefore, these methods cannot be used to pinpoint the specific cause(s) of non-uniformity.

Afera: Association des Fabricants Europeens de Rubans Auto-Adhesives (Association of European Tape Manufacturers)

ASTM: American Society for Testing and Materials (USA)

EN: European Norm (Europe)

PSTC: Pressure Sensitive Tape Council (North America)

## **2. REFERENCED DOCUMENTS**

### **2.1 ASTM Standards:**

D 3654/D 3654M Standard Test Method for Holding Power of Pressure-Sensitive Tapes

D 3715 Practice for Quality Assurance of Pressure-Sensitive Tapes

D 5750 Guide for Width and Lengths of Pressure-Sensitive Tapes

### **2.2 AFERA Standards:**

2.2.1 AFERA 5012 Self Adhesive Tapes - Measurement of Static Shear Adhesion

### **2.3 CEN Standards**

2.3.1 EN 1943 Self Adhesive Tapes - Measurement of Static Shear Adhesion

2.3.2 EN 10088/2, 2R - Specification for Stainless Steel Plate

### **2.4 PSTC Standards:**

2.4.1 PSTC-107 Shear Adhesion of Pressure Sensitive Tape

## **3. SUMMARY OF TEST METHOD**

3.1 Procedure A - Shear adhesion to standard steel panel - A strip of tape is applied to a standard steel panel under controlled roll down. The panel is mounted vertically, a standard mass is attached to the free end of the tape and the time to failure is determined.

3.2 Procedure B - Shear adhesion to a standard NIST fiberboard - A strip of tape is applied to a panel covered with NIST SRM 1810A fiberboard under controlled pressure. The panel is mounted vertically, a standard mass is attached to the free end of the tape and the time to failure is determined.

3.3 Procedure C - Shear adhesion to a vertical fiberboard surface with controlled roll down (see Figure 1). The fiberboard, corrugated board, or other substrate agreed upon prior to testing and described in the report section. A standard mass is attached to the tape and the time to failure is determined (see Figure 2).

3.4 Procedure D - Shear adhesion to a standard steel panel. A strip of filament-reinforced tape is applied to a standard steel panel with a 120° bend at one end with controlled roll down. The panel is mounted horizontally, tape side up, with the free end of the tape allowed to hang vertically over the rounded end. A standard mass is attached to the end of the tape and allowed to act for specified time.

3.5 Procedure E - Shear adhesion of filament reinforced tape to a standard (NIST) fiberboard - A strip of reinforced filament tape is applied to a panel with a 120° bend, covered with NIST SRM 1810A standard fiberboard under controlled roll down. The panel is mounted horizontally, tape side up, with the free end of the tape allowed to hang vertically over the rounded end of the panel. A standard mass is attached to the end of the tape and allowed to act for specified time (see Figure 3).

3.6 Procedure F - Shear adhesion of filament reinforced tape to a fiberboard - A strip of reinforced filament tape is applied to a panel with a 120° bend at one end under controlled roll down. The panel is covered with a fiberboard, corrugated board or other substrate agreed upon prior to testing and described in Section 12. The panel is mounted horizontally, tape side up, with the free end of the tape allowed to hang vertically over the round end of the panel. A standard mass is attached to the end of the tape and allowed to act for a specified time.

3.7 Procedure G - This test method is conducted as described in Procedure A except the test is conducted at an elevated temperature.



3.8 For Procedures A, B, C, and G the normal test area shall be 12 by 12 mm. A test area of 24 by 24 mm may be specified.

3.9 For Procedures D, E, F, the specimen width shall be 12 mm.

#### **4. SIGNIFICANCE AND USE**

4.1 Procedure A measures the ability of a pressure sensitive tape to adhere to a standard steel panel under constant stress. This may or may not relate to the ability of the tape to adhere to other surfaces.

4.2 Procedure B may be used to determine the shear adhesion of tapes generally used to close fiberboard boxes in packaging applications.

4.3 Procedure C measures the ability of a pressure sensitive tape to adhere to a non-standard fiberboard, linerboard or other substrate which is agreed upon for testing. This may be used to compare the shear adhesion of tapes to a particular surface or to compare the shear adhesion of a tape to a variety of surfaces.

4.3.1 The surface of similar fiberboard may exhibit considerable variations between paper mills, between batches from one mill, and within batches. Take care in the choice of samples and when comparing test results between substrates which may not be exactly the same.

4.3.2 The precision of test conducted on non-standard surfaces may be different from that described in section 13.

4.4 Procedures D, E, and F may be used to determine the ability of a filament reinforced tape to hold when placed under constant stress. The reinforced tapes may also be tested using Procedures A, B, and C.

4.5 Procedure G may be used to compare the shear adhesion of tape when applied to a standard steel surface and tested at an elevated temperature (see 10.6.3 and 12.1.8).

#### **5. APPARATUS**

5.1 Specimen cutter - The specimen cutter shall hold two single edge razor blades in parallel planes, a precise distance apart, to form a cutter of exact specimens widths. Two cutters, 12 and 24 mm cutting width, shall be available or appropriate alternates which will not cause edge damage.

Note 1 - The 12 mm cutter shall consist of a bar stock 1 mm wide. The edges for about 125 mm from one end shall be slightly rounded to form a handle. The width of the end of the bar shall be narrowed to exactly 12 mm minus the thickness of a single edge razor (one of two used as cutting edges). The razor blades shall be held in position using side plates. The end of the cutter shall be cut away at a 45° angle to expose the cutting edge at one end of the blades. The edges shall be separated by  $12 \pm 0.10$  mm. The 24 mm cutter shall follow the same description except the bar stock shall be 24.0 mm wide and shall be narrowed to exactly 24 mm minus the thickness of a single edge razor.

Note 2 - These widths correspond to the primary metric (SI) units described in ASTM D 5750. If it is desirable to test slightly different widths (e.g. 12.5 or 25 mm) of specimens per 9.4, this should be noted per 12.1.5.

Note 3 - There may be several suppliers of these items. See Appendix B.

5.2 Dispensing system, for solvents, such as a wash bottle

### 5.3 Panel

5.3.1 For Procedures A, B, C, and H, a panel at least 50 mm long and 50 mm wide and not less than 1.1 mm thickness stainless steel 302 or 304 in accordance with Specification EN 10088/2, 2R having a bright annealed finish. The surface roughness height shall be  $50 \pm 25$  nm arithmetical average deviation from the mean line. One or both panel ends shall be ground to form a  $90^\circ$  angle with the surface. Panels showing stains, discoloration, or many scratches are not acceptable. New panels should be cleaned prior to use as 10.2.1, except with ten washes of the final solvent. Between uses, the panel test surface shall be protected from scratches and contamination, and the panels stored at conditions described in 8.1.

5.3.2 For Procedures D, E, and F, a panel as described in 5.3.1 shall have a 12 mm length of one end of the panel bent through an arc of  $120^\circ$  away from the test surface. The radius of the curvature of the finished surface at the bend shall be 1.5 to 3 mm.

### 5.4 Roller, mechanically or hand operated

5.4.1 A steel roller  $85 \pm 2.5$  mm, in diameter and  $45 \pm 1.5$  mm in width, covered with rubber approximately 6 mm in thickness, having a Shore scale A durometer hardness of  $80 \pm 5$ . The surface shall be a true cylinder void of any convex or concave deviations. The mass of the roller shall be  $2 \text{ kg} \pm 0.1 \text{ kg}$ .

5.4.2 No part of the apparatus shall increase the pressure of the roller during use. The roller shall move either mechanically or by hand at the rate of  $10 \pm 0.5 \text{ mm/s}$ . (See Figure 5.)

### 5.5 Test stands and ancillary apparatus

5.5.1 Procedures A, B, C, and G - A test stand that shall hold the test panel (see Figure 6), with the tape applied, at an angle of  $2^\circ$  with the vertical, so that when the mass is acting on the test specimen, no peel forces will be exerted on the tape.

5.5.2 Procedures D, E, and F - A test stand that will support the test panel in a horizontal plane, approximately 300 mm above the work surface.

5.5.3 Clamp, that will allow the attachment of the mass to the specimen, distributing the load equally across the tape specimen width.

#### 5.5.4 Test masses

5.5.4.1 Procedures A, B, D, and H. The test mass shall be  $1000 \pm 5 \text{ g}$  or other mass as specified. The mass of the clamp described in 5.5.3 shall be included as part of the total mass.

5.5.4.2 Procedures D, E, and F. The test mass shall be  $4.5 \pm 0.2 \text{ kg}$  or other mass as specified. The mass of the clamp described in 5.5.3 shall be included as part of the total mass.

#### 5.5.5 Timing system

5.5.5.1 For Procedures A, B, C, and G, to measure the interval between the application of the load to the specimen and its separation from the panel.

5.5.5.2 For Procedures D, E, and F, a suitable means of measuring the amount of slippage of the tape to 1 mm on the panel after the mass has acted for 48 h.

## 6. REAGENT MATERIALS

6.1 Purity of reagents - Reagent grade chemicals should be used in all tests. Other grades may be used, provided it is first ascertained the reagent is of sufficiently high purity to permit its use without lessening accuracy of the determination.

## 6.2 Solvents

6.2.1 Any of the following solvents may be used for cleaning:

6.2.1.1 Diacetone alcohol non-residual, technical grade or better

6.2.1.2 Methanol (95%)

6.2.1.3 Methyl Ethyl Ketone (MEK)

6.2.1.4 n-Heptane

6.2.1.5 Acetone

6.2.2 For final cleaning, before each test, MEK or acetone shall be used.

6.3 Cleaning material, absorbent; surgical gauze, cotton wool or tissue. To be suitable, materials must be lint-free during use, absorbent, contain no additives that are soluble in the solvents listed in 6, and made exclusively from virgin materials.

## 7. SAMPLING

7.1 Sampling shall be in accordance with ASTM Practice D 3715/D 3715M or other formal sampling procedure agreed to by both parties for referee testing. Five replicate specimens shall be averaged for all procedures. No single value shall be considered as representative of the roll under test.

## 8. CONDITIONING

8.1 Condition the sample rolls of tape in the standard conditions of  $23 \pm 1^\circ \text{C}$  and  $50 \pm 5\% \text{RH}$ . Test at these conditions unless otherwise specified (see 12.1.7). If these tolerances cannot be maintained, the closest possible tolerances shall be used and these revised tolerances quoted in the report (see 12.1.7).

Note 4 - Caution: The tester should know that by prolonged handling of the test panel, heat from the hand is transmitted to the test panel. Therefore, just prior to, during, and after application of the specimen to the test panel, the panel should be handled as little as possible.

## 9. TEST SPECIMENS

9.1 Removal from roll

9.1.1 Unwind and discard at least three but no more than six outer wraps of tape from the sample roll before taking specimens for testing.

9.1.2 Remove three specimens per sample roll for each test to be performed for Procedures A, D, and G; and five specimens per roll for Procedures B, C, E, and F. Remove specimens from freely rotating roll at the rate of 500 to 750 mm/s. Where width or other factor causing a high adherence to backing makes it impossible to remove the specimen at the prescribed rate, remove it at a rate as close to 500 mm/s as possible.

9.2 When tape is wider than specified for in the test method, cut the specimen from the center of the strip removed from the roll in accordance with 9.1.2.

9.3 Apply specimen shortly after unwinding (within 5 minutes).

9.4 Test specimen size.

9.4.1 Procedures A, B, C, and G. The test contact area shall be  $12 \pm 0.5$  by  $12 \pm 0.5$  mm, or other width, as specified ( $24 \pm 0.5$  mm by  $24 \pm 0.5$  mm may be used). The length of the specimen shall be approximately 150 mm.

9.4.2 Procedures D, E, and F specimens shall be  $12 \pm 0.5$  mm in width and approximately 300 mm long.

## 10. PROCEDURES

10.1 For Procedures B and C, apply by means of a double-coated pressure-sensitive tape a 30 by 75 mm piece of fiberboard (see 3.2, 3.3) with the 30 mm dimension centered on the 50 mm dimension at one end of the test panel (see 5.3.1 and 5.3.2).

Note 5 - Take care that the fiberboard is applied with the proper side up and is oriented so that the grain of the paper, machine direction (MD), is perpendicular to the intended direction of the shear stress.

### 10.2 Procedure A

10.2.1 Dispense one of the solvents listed in 6.2.1 onto the panel, wiping to dryness with fresh absorbent cleaning material. Repeat for a total of three washes with this solvent. Final wipe shall be MEK or acetone. Panels not used within 10 hours should be recleaned.

Note 6 - Discard panels showing stains, discoloration, or many scratches. Avoid contacting panel surface with fingers. During storage, panels should be protected from damage or contamination.

10.2.2 Center the test specimen on the 50 mm dimension at one end of the test panel and apply without added pressure to cover an area exactly 12 x 12 mm, unless other width specified, with the tape. Mask the exposed adhesive of the free area of the specimen.

10.2.3 To prevent cutting the specimen by the end of the panel during roll down, place another panel of the same or slightly lesser thickness under the free masked end of the specimen, and in contact with the end of the panel prior to roll down. Roll down the applied test area twice in each lengthwise direction.

10.2.4 Individually prepare each specimen and test within 1 minute. For tapes other than packaging tape, other dwell times may be used but must be reported (See 12.1.4).

10.2.5 Place the clamp on the masked free end of the specimen, ensuring that the clamp extends completely across the width of the specimen and is aligned to uniformly distribute the load.

10.2.6 Place the test assembly in the test stand so that the free end of the test specimen is vertical, ensuring that no peel forces act on the specimen.

10.2.7 Apply the 1000 g mass to the clamp gently so as to cause no impact force on the tape specimen. Record the time elapsed until the specimen has completely separated from the test panel. (See Figure 4.)

### 10.3 Procedures B and C

10.3.1 Conduct these tests as described in 10.2 except the test panel shall be covered with fiberboard described in 10.1

### 10.4 Procedure D

10.4.1 Clean, as described in 10.2.1, a test panel described in 5.3.1.

10.4.2 Apply one end of the specimen, about 100 mm in length, adhesive side down, to the longitudinal surface of the test panel. The tape must be at a true right angle to the bent edge of the panel. Allow the remaining length to extend over and beyond the bend edge of the panel.

10.4.3 Using a square, cut across and through the width of the tape specimen 75 mm back from the front of the bend in the horizontal plane of the test panel surface.

10.4.4 Roll twice, once in each lengthwise direction.

10.4.5 Place the clamp on the free end of the specimen, ensuring that the clamp extends completely across the width, and is aligned so as to distribute the load uniformly.

10.4.6 Place the test assembly in the test stand so that the panel is horizontal, tape side up, and the free end of the test specimen in vertical. Apply the 4.5 kg mass to the clamp gently so as not to cause any impact force on the specimen.

10.4.7 At the end of 48 h under load, examine the specimen for evidence of slippage. Measure any slippage that has occurred to the nearest 1 mm. (See Figure 4.)

## 10.5 Procedures E and F

10.5.1 Conduct these tests as described in 10.4 except the test panels shall be covered with fiberboard as described in 10.1.

## 10.6 Procedure G

10.6.1 Prepare test specimens as described in 10.2.1, 10.2.2, 10.2.3, 10.2.4, and 10.2.5.

10.6.2 Place the test stand, with specimen in place, in an oven maintained at  $50 \pm 1^\circ\text{C}$ , or other temperature, as specified.

10.6.3 Allow to condition for 10 min., then apply the 1000 g mass to the clamp gently so as not to cause any shear impact force on the tape specimen. Record the time lapsed in which the tape specimen has completely separated from the test panel (See 12.1.8).

## 11. CALCULATIONS

11.1 Procedures A, B, C, and G - To determine the test results for each roll of tape, convert each of the five specimen test results (times to failure) to its common or natural logarithm. Obtain the arithmetic mean of all logarithms and then convert back to time by obtaining the appropriate antilogarithm. This gives the test result for the roll of tape under consideration in the sampling plan.

11.2 Procedures D, E, and F - The average slippage in mm shall be reported.

## 12. REPORT

12.1 The report shall include the following:

12.1.1 Statement including which test method was used and indicating any deviation from the method as written.

12.1.2 Identify the source of each roll of tape.

12.1.3 For Procedures A, B, C, and G, the time for the tape to separate completely from the panel. For Procedures D, E, and F, the amount of slippage in mm to the nearest mm.

12.1.4 Dwell time, if other than the standard 1 minute.

12.1.5 Test specimen size for Procedures A, B, C, and G if other than 12 by 12 mm. Width of specimen for Procedures E, F, and G if other than 12 mm.

12.1.6 Conditioning if other than  $23 \pm 1^\circ\text{C}$  or  $50 + 5\% \text{ RH}$ .

12.1.7 Test temperatures for Procedures A, B, C, D, E, and F, if other than  $23^\circ\text{C}$  and test temperature for Procedure G, if other than  $50^\circ\text{C}$ .

12.1.8 Mode of failure - Cohesion (cohesive strength, internal bond) - The ability of the adhesive to resist splitting. Good cohesion is necessary for clean removal. Adhesion - A bond produced between a pressure sensitive tape adhesive and a surface for Procedures A, B, C, and G.

12.1.9 Fiberboard substrate if Procedure C or F is used.

### 13. PRECISION AND BIAS STATEMENT

13.1 The surfaces of similar fiberboard may exhibit considerable variations between paper mills, between batches from one mill, and within batches, therefore results using different fiberboard should not be compared except when one wishes to use Procedure C as a means of comparing how well a given tape will adhere to different fiberboards.

### 14. KEYWORDS

14.1 Pressure sensitive tape, filament tape, shear adhesion.

---

### SUMMARY OF CHANGES

- Corrected unit of measurement for surface roughness in section 5.3.1, line 3
- Required five replicate samples for all procedures in section 7.1



Figure 1. Controlled roll down shear adhesion sample preparation.

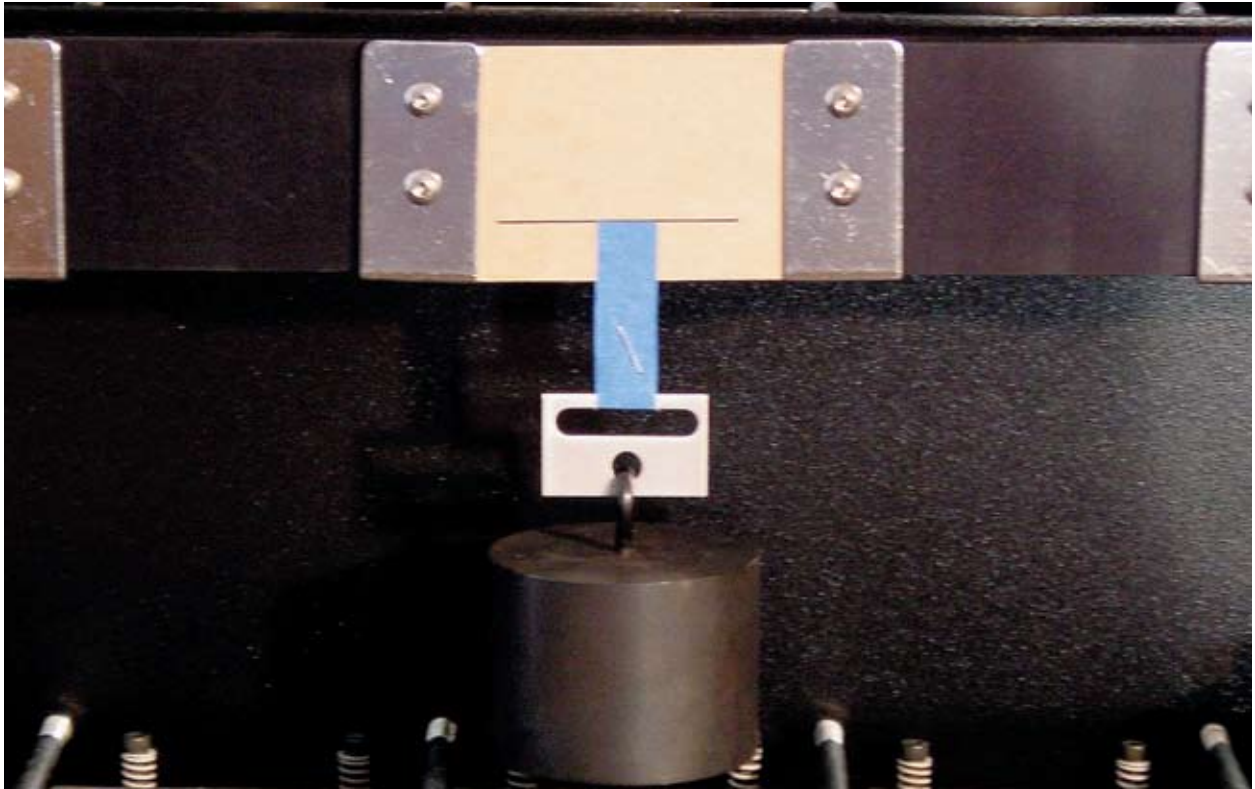

Figure 2. Shear adhesion sample preparation with weight.

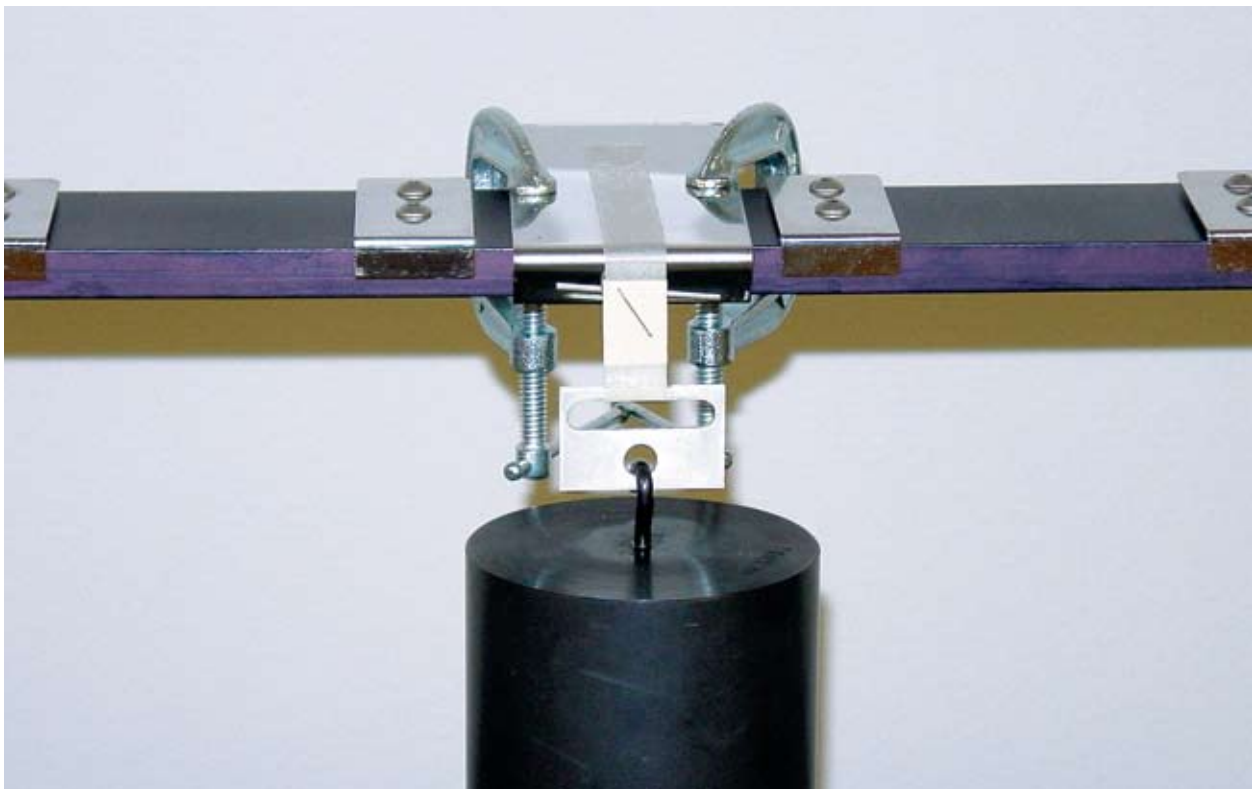

Figure 3. Shear adhesion sample in test stand (initial).

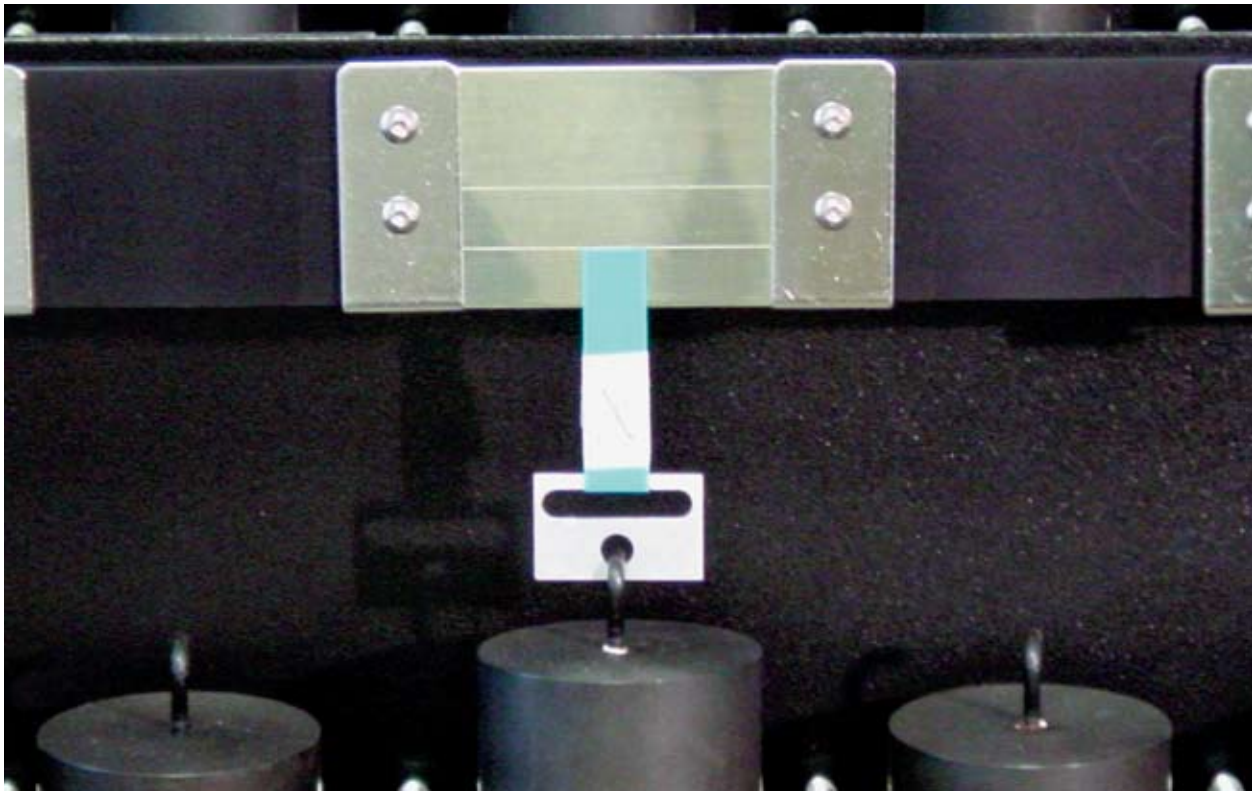

Figure 4. Shear adhesion sample in test stand (final).



Figure 5. Sample preparation for shear adhesion hand roll down.



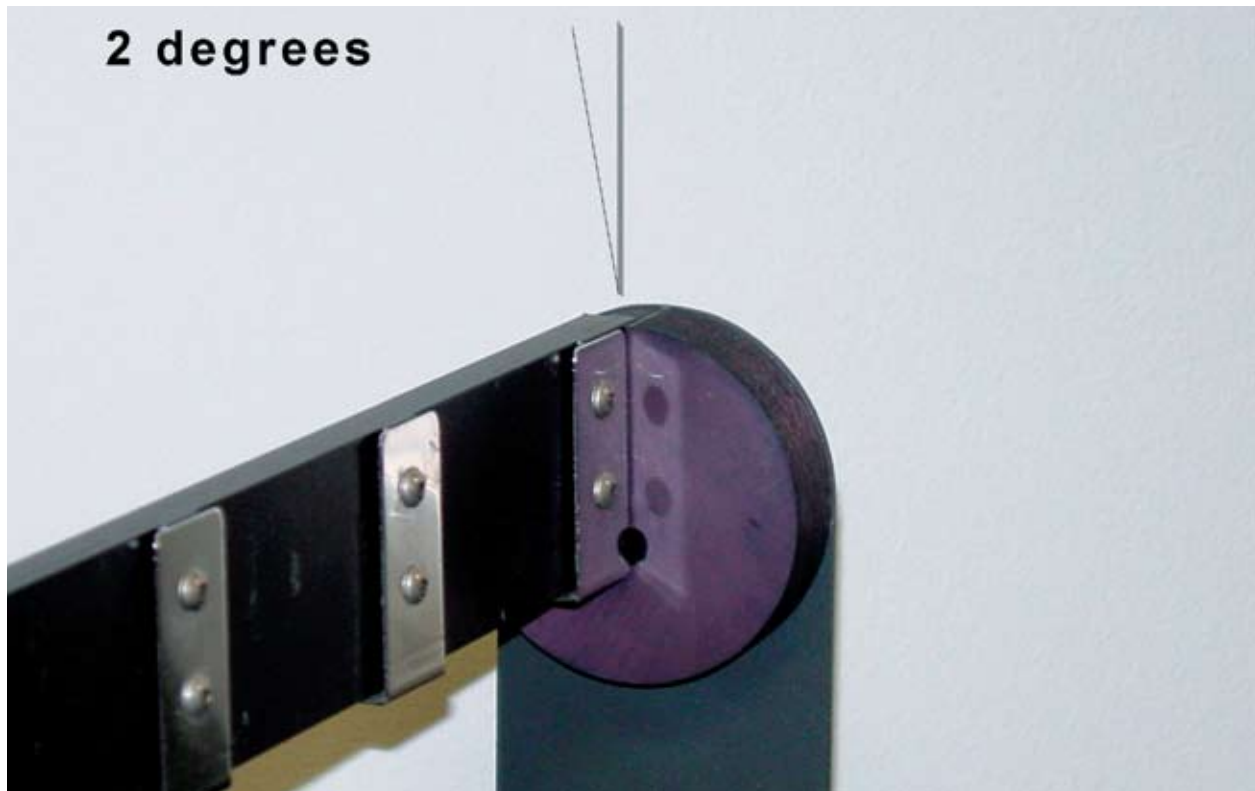

Figure 6. Test stand for shear adhesion.



Call Letters	PSTC-8
Date of Issuance	09/55
Revised	04/66
Revised	11/70
Revised	08/85
Revised	08/89
Revised	06/00
Revised	10/03
Revised	05/07

# Unwind Force of Pressure Sensitive Tape

## 1. DEFINITION

1.1 Unwind adhesion is the force required to remove the tape from the roll under prescribed conditions.

## 2. SIGNIFICANCE

2.1 Unwind adhesion is a quantitative measure of the degree of ease or difficulty in unwinding a roll of tape.

## 3. TEST SPECIMEN

3.1 For test specimen conditioning, selection, and test conditions, see Appendices A & D.

3.2 The test specimen shall be any 10 m (10 yard) or more roll of pressure sensitive tape - preferably 24 mm (1") wide.

## 4. EQUIPMENT - See Appendix B

4.1 Tensile tester.

4.2 Fixture, unwind, with a free turning mandrel for mounting roll in test machine.

## 5. TEST METHOD

5.1 Mount roll of tape in lower jaw of machine using free turning roller assembly. Place free end of tape in upper jaw (see Figure 1) and operate lower jaw at 300 mm/min (12"/min).

5.2 After 24 mm (1") of tape has been mechanically unwound, observe the maximum value obtained during the unwinding of the next 150 mm (6").

5.3 The tape unwound should be examined for transfer of adhesive, delamination, tearing, or other occurrence.

5.4 Repeat sections 5.1 through 5.3 four more times for a total of five replicate tests.

## 6. REPORT

6.1 Report the unwind adhesion value in Newtons for 24 mm (lbs./inch) to the nearest 0.02 Newton (0.05 lbs.) or other suitable unit. If other than 24 mm (1") widths are tested, 24 mm (1") values are found as the result of dividing the observed value by the specimen width.

Another method for measuring unwind force of pressure sensitive tapes is ASTM D 3811.

---

## SUMMARY OF CHANGES

- Added section 5.4

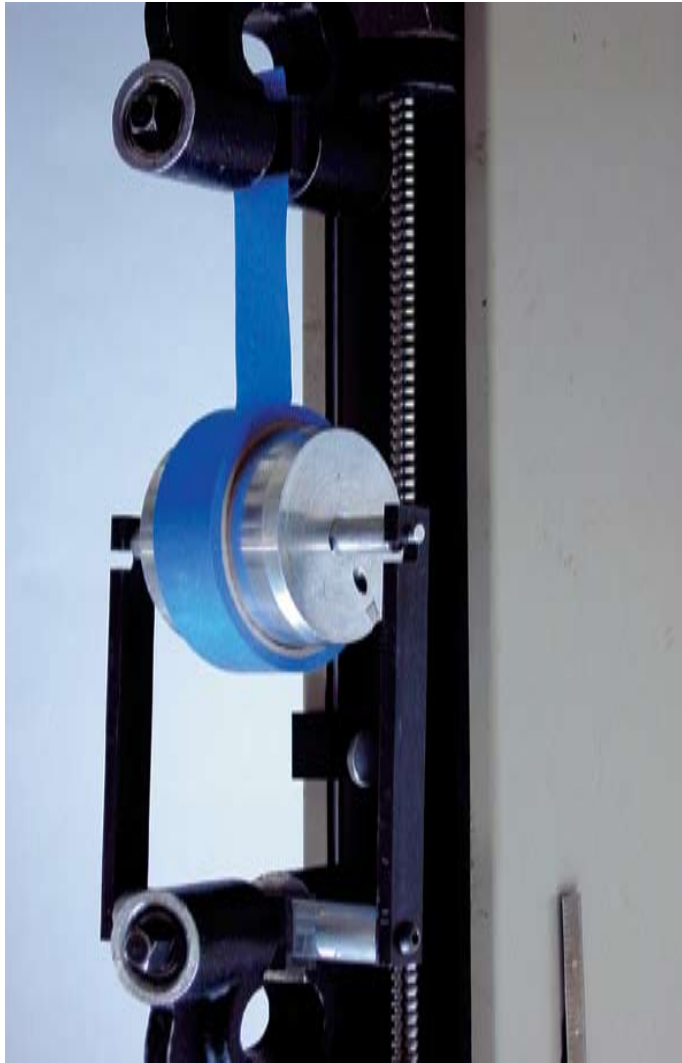

Figure 1. Setup of roll on mandrel.

Call Letters	PSTC-9
Date of Issuance	01/57
Revised	04/66
Revised	11/70
Revised	08/85
Revised	08/89
Revised	06/00
Revised	10/03

## Accelerated Aging of Pressure Sensitive Tape

### 1. DEFINITION

1.1 This method provides one environment in which to expose finished pressure sensitive tape material for the purpose of accelerating the aging of it. It is applicable to tape in roll form. It does not provide for a conclusion within itself, but is for use in conjunction with appearance or physical property tests to be conducted prior to and after the accelerated aging exposure. It is generally applicable to all types of pressure sensitive tapes with the possible exception of electrical grade tapes (see ASTM D 1000).

### 2. SIGNIFICANCE

2.1 This method accelerates natural aging of pressure sensitive tapes so that the response to the physical property tests changes to the same extent as with an exposure to at least 2 years of natural aging when compared with the response to test before aging.

2.1.1 Natural aging in this context means a continuous period of aging of tape in a closed fiberboard container (in darkness) in the variable climate of either the warm moist south, the warm dry southwest, or the moderate mid-continent, USA.

2.2 The extent of change for one physical property could be expected to be different than for another property and so would also relate to different natural aging time.

2.3 An abnormal product lot may cause differences in testing response that throw off the expected time patterns.

2.4 Appearance of normal tape product will usually change only slightly in 2 years natural aging. This accelerated exposure usually produces an exaggerated change in appearance that would be seen under natural conditions only in abnormal product.

2.5 There is no present experience to relate this accelerated exposure to responses to tape in applications where the tape is under an in-use stress.

### 3. TEST SPECIMEN

3.1 The sample should consist of rolls of tape.

3.1.1 The quantity of tape in any sample roll need not be more than necessary to supply the specimens for the physical property tests to follow the exposure.

3.1.2 No sample roll should be less than 12 mm (1/2") in width.

3.1.3 Sample rolls should be originally wound, not rewound rolls.

### 4. EQUIPMENT

4.1 A vessel to contain a solution of ammonium sulfate and tape undergoing exposure. The vessel must meet the following requirements:

4.1.1 Vented to allow equilibrium with an opening no greater than pinhole size.

A Summary of Changes section appears at the end of this test method.

4.1.2 The air volume over the solution to be not more than 10% greater than the cube of the square root of the liquid surface area.

4.1.3 The air depth of the vessel to the liquid surface to be not more than 10% greater than the square root of the liquid surface area.

4.1.4 A desiccator assembly with a perforated plate can be a suitable vessel.

4.2 An oven of the forced-convection type maintained at a mean of  $65.5^{\circ}\text{C} \pm 1^{\circ}\text{C}$  ( $150^{\circ}\text{F} \pm 2^{\circ}\text{F}$ ).

4.3 The purity of the reagents used shall be reagent grade. Other grades may be used, provided it is first ascertained that the reagent is of sufficient high purity to permit its use without lessening the accuracy of determination.

4.4 Ammonium sulfate  $(\text{NH}_4)_2\text{SO}_4$ .

4.5 Water, distilled or demineralized.

4.6 The reagents of 4.4 and 4.5 are to be dissolved in the proportion of 1:1 by weight. Use a volume (the units will be cubic centimeters) of water not less than that obtained by multiplying 500 times 132 times the vessel air volume in cubic meters. This gives 500 times the number of grams of water required to humidify the air volume to 80% relative humidity at  $65.5^{\circ}\text{C}$  ( $150^{\circ}\text{F}$ ) and should supply the moisture required to accommodate the absorption by the sample rolls. This provides a saturated solution which will remain saturated at  $65.5^{\circ}\text{C}$  ( $150^{\circ}\text{F}$ ). This solution within the closed vessel both provides and controls the moisture content (humidity) within the vessel.

Note:

An oven or chamber (environmental) capable of maintaining a set temperature of  $65.5^{\circ}\text{C} \pm 1^{\circ}\text{C}$  ( $150^{\circ}\text{F} \pm 2^{\circ}\text{F}$ ) and  $80\% \pm 2\%$  relative humidity may be used as alternate conditioning equipment.

## 5. TEST METHOD

5.1 Place the sample rolls above the solution in the vessel so that roll edges lie in a horizontal plane (parallel with the liquid surface).

5.1.1 Include no more sample rolls than will displace one-fourth of the air volume in the vessel.

5.1.2 Arrange the sample rolls so that all surfaces are exposed to the humid air in the vessel. Use separators that allow free air space around and between the rolls and which are non-hygroscopic. Figure 1.

5.2 Close the assembly and place in the oven.

5.2.1 Assure that care is taken to prevent the solution from wetting any part of the assembly (including tape), other than the reservoir it occupies, when the assembly is moved in and out of the oven. This reduces salt deposition and crystalline buildup.

5.3 Remove the assembly from the oven after 96 hours. Immediately remove the sample rolls from the assembly.

5.4 Condition the sample rolls at standard conditions (Appendix A) for a minimum of 4 hours with free space around them.

5.5 After at least 4 hours of conditioning (some test materials may require 24 or 48 hours to reach equilibrium), remove at least three wraps but no more than six wraps of tape from the roll, then unwind several wraps of tape from the roll at 500-750 mm per second (20 to 30"/s) while allowing the roll to turn freely. Observe this unwound tape for adhesive stringiness or offsetting and note any tearing, breaking, or delamination of the backing.

5.6 Remove additional specimens as described in 5.5 for any tests specified.

## 6. REPORT

6.1 Report any pertinent observations while performing paragraph 5.5.

6.2 Report the value(s) found while performing paragraph 5.6.

Another method for determining the accelerated aging characteristics of pressure sensitive tapes is ASTM D 3611.

---

## SUMMARY OF CHANGES

No changes from the 14th edition.



Figure 1. Vessel assembly.





Call Letters	PSTC-11
Date of Issuance	05/59
Revised	08/85
Revised	08/89
Revised	06/00
Revised	10/03

# Adherence to Linerboard Of Pressure Sensitive Tapes At Low Temperature

## 1. DEFINITION

1.1 This method provides one procedure for determining the adherence of pressure sensitive tapes to a standard linerboard or other similar surface.

## 2. SIGNIFICANCE

2.1 Satisfactory tape performance at the test temperature implies satisfactory cold temperature performance at or above the test temperature.

2.2 This procedure would be applicable for questions of adherence to 100% kraft fiberboard similar to the standard linerboard surface without substitution but for direct information on any board or surface the actual surface in question should be substituted.

## 3. TEST SPECIMEN

3.1 The specimen shall be 12 mm to 24 mm (0.5" to 1.0") wide. The length shall be a maximum of 150 mm (6.0").

3.2 Remove specimens from the rolls at a rate of 50 to 75 cm/s (20 to 30"/s) after having first unwound at least three but no more than six wraps of tape (see Appendix D).

## 4. EQUIPMENT - See Appendix B

4.1 NIST (National Institute of Standards and Technology, USA) Standard Reference Material 1810A,<sup>1</sup> length approximately 275 mm (11"), width approximately 12 mm (1/2") wider than the specimen width (see 3.1). When agreed upon by the parties involved or when called for by the material specification, other flexible material may be substituted for the 1810 linerboard.

4.2 Roller, 2 kg (4 1/2 lb.), rubber covered.

4.3 Oven, circulating, maintained at 65.5°C ± 1°C (150°F ± 2°F).

4.4 Cold chamber, maintained at a specified temperature, -54°C ± 1°C (-65°F ± 2°F), if no other temperature is specified.

4.5 Nonrotating, smooth surface, metal cylinder, having a diameter of 37.5 ± 6 mm (1.5 ± 0.25") and minimum length of 50 mm (2") fixed to a base of support for use as a mandrel around which to flex the tape specimen assembly (see Figure 1).

## 5. TEST METHOD

5.1 Except when stated elsewhere in this method, prepare and condition the sample material in an atmosphere uniformly maintained at standard conditions (see Appendix A) for a period of not less than 24 hours.

5.2 Apply the specimen centrally to the linerboard strip. Roll over the tape against a flat smooth surface using the rubber-covered roller. Make two passes, one in each lengthwise direction at the rate of 300 mm/min (12"/min).

<sup>1</sup>Standard Reference Material 1810A is available from the Office of Standard Reference Materials, National Institute of Standards and Technology, Washington D.C. 20234.

A Summary of Changes section appears at the end of this test method.

5.3 Expose the specimen assembly to a temperature of  $65.5^{\circ}\text{C} \pm 1^{\circ}\text{C}$  ( $150^{\circ}\text{F} \pm 2^{\circ}\text{F}$ ) for 24 hours. Within the next 24 hours, expose the specimen assembly together with the 37.5 mm (1.5") mandrel, to the specified temperature for 2 hours. If no temperature is specified, specimen should be conditioned at  $-54^{\circ}\text{C} \pm 1^{\circ}\text{C}$  ( $-65^{\circ}\text{F} \pm 2^{\circ}\text{F}$ ) in the cold chamber for 2 hours.

5.4 Without removing the specimen assembly from the cold environment, nor effecting any change in that temperature, hold an extreme end (linerboard only) in each hand. With the linerboard side of the assembly against the mandrel, draw first one end and then the other forward so that both ends of tape on the linerboard will have formed into the curve of the mandrel. Draw the ends forward in turn at the rate of 600 mm/s (24"/s). Keep the ends of the assembly taut and parallel forming an  $180^{\circ}$  bend. End the drawing with the assembly at the same position as when starting, having completed one complete cycle.

5.5 Observe the tape and linerboard during and following the drawing for any evidence of release of tape from the linerboard.

## 6. REPORT

6.1 Report temperature at which the test was conducted.

6.2 Report the observation made in 5.5, that is, whether the tape did or did not release from the linerboard.

Another method for measuring adherence to linerboard of pressure sensitive tape at low temperature is ASTM D 3889.

---

## SUMMARY OF CHANGES

No changes from the 14th edition.



Figure 1. Mandrel for adherence to linerboard test.

Call Letters	PSTC-13
Date of Issuance	11/70
Revised	08/85
Revised	08/89
Revised	06/00
Revised	10/03
Revised	05/07

# High Speed Unwind Adhesion of Pressure Sensitive Tapes

## 1. DEFINITION

1.1 Unwind adhesion is the force required to remove the tape from the roll under prescribed conditions.

## 2. SIGNIFICANCE

2.1 Unwind adhesion determines the force needed in unrolling a roll of tape. Unwinding at high speed will give indication of the unwind performance in use.

## 3. TEST SPECIMEN

3.1 For test specimen conditioning, selection, and test conditions, see Appendices A & D.

3.2 The test specimen shall be a roll of pressure sensitive tape with a diameter of 220 mm (9") or less - preferably 24 mm (1") wide but no wider than 48 mm (2").

## 4. EQUIPMENT

4.1 An unwind machine capable of unwinding the roll at a constant rate of 60 m/min  $\pm$  3 m/min (200 ft  $\pm$  10 ft/min) having a means of sensing and indicating the unwind force measured parallel to the unwinding strip with a capacity to test rolls through 48 mm (2") in width and a diameter of 220 mm (9") wound on cores of a nominal inside diameter of 72 mm (3"). The force-measuring system shall have a sensitivity of 0.2 Newtons (0.05 lb.) with a capacity of at least 4.4 Newtons (10 lb.) and shall indicate the force on a scale calibrated to 0.2 Newtons (0.05 lb.).

## 5. TEST METHOD

5.1 Place specimen roll on unwind machine (see Figure 1). Initiate unwinding at 60 m/min (200 ft/min).

5.2 Read and record indicated unwind force at approximately 25%, 50%, and 75% of the way through the roll.

5.3 The tape unwound should be examined for transfer of adhesive, delamination, tearing, or other occurrence.

## 6. REPORT

6.1 Report the unwind adhesion value in grams per centimeter (ounces per inch) of width to the nearest 10 g (1 oz.) as the average of three readings recorded in 5.2. If other than 24 mm (1") widths are tested, 24 mm (1") values are found as the result of dividing the observed value by the specimen width.

6.2 Report any observation made in paragraph 5.3.

---

## SUMMARY OF CHANGES

- Corrected diameter measurement in sections 3.2 and 4.1 to 220 mm.



Figure 1. Setup of roll on unwind tester.

Call Letters	PSTC-14
Date of Issuance	11/70
Revised	08/85
Revised	08/89
Revised	06/00
Revised	10/03
Revised	05/07

# Adhesion of Pressure Sensitive Tapes To Fiberboard at 90° Angle and Constant Stress

## 1. DEFINITION

1.1 Adhesion to fiberboard at 90° angle and constant stress is the time required to remove a unit length of a pressure sensitive tape from a given fiberboard under a controlled constant stress. The user of this method has the option of choosing the paper surface for the test. The test surface shall be the standard linerboard.<sup>1</sup> If another linerboard or paper is used, it should be noted in the test report.

## 2. SIGNIFICANCE

2.1 This test is designed to show the adhesion of a pressure sensitive tape to fiberboard when the tape is under constant stress. Test data from this test for some types of packaging tapes relate to tape performance on fiberboard box closure.

2.2 Procedure A should be used when comparing tape to an established requirement. The requirement may be established using either the standard linerboard or another linerboard representing a specific fiberboard.

2.3 Procedure B should be used to rank tapes as to their ability to adhere to fiberboard.

## 3. SPECIMEN

3.1 For test specimen conditioning, selection, and test conditions, see Appendices A & D.

3.2 A roll or rolls of tape for testing must be at least 36 mm (1.5") in width. Test five specimens from each roll of tape.

## 4. EQUIPMENT

4.1 Double coated pressure sensitive tape 48 mm (2") in width. Tape must exhibit sufficient adhesion to the test panel and to the fiberboard or test specimens for duration of test.

4.2 Panel, any steel piece at least 50 mm x 125 mm x 1.6 mm (2" x 5" x 1/16") having one surface 50 x 125 mm (2" x 5") that does not deviate from a plane by more than 0.05 mm (0.002").

4.3 Stop watch.

4.4 Cutting device for preparing fiberboard and tape specimens.

4.5 Mask, any paper no more than 0.05 mm (0.002") thick formed by a rectangle approximately 125 x 62.5 mm (5" x 2.5") with a rectangular hole exactly  $24 \pm 0.25$  by 31 mm ( $1.0" \pm 0.01"$  by 1.25") centered in the piece. The 24 mm (1") hole is to be in the 125 mm (5") direction. See Figures 1 and 2.

4.6 Chipboard piece, approximately 1" x 1" (24 x 24 mm) for reinforcement.

4.7 Single hole paper punch.

4.8 Fiberboard or linerboard one surface against which the test is made.

A Summary of Changes section appears at the end of this test method.

4.8.1 For Procedure A, cut a rectangle exactly  $24 \pm 0.25$  mm ( $1.0'' \pm 0.01''$ ) wide by at least 125 mm (5'') in length from the linerboard representing the fiberboard on which the tape will be used. The long dimension shall lie at a right angle to the machine direction of the linerboard. Reinforce the end of the strip with a chipboard piece adhered with double coated tape. Punch a hole at the center of the reinforcement.

4.8.2 For Procedure B, cut a rectangle, preferably 125 x 48 mm (5'' by 2''), but no less than 48 x 48 mm (2'' by 2''), from the fiberboard on which the tape will be used (or linerboard representing it). The long test dimension shall lie at a right angle to the machine direction of the linerboard.

4.8.3 For either procedure, prepare the linerboard or fiberboard in advance of testing and mark it to show which side to use. When comparing one roll of tape to another or one lot of tape to another, the linerboard or fiberboard should be from a single lot.

4.9 Rubber-covered roller. See Appendix B.

4.10 Test stand to support the panel securely in a horizontal plane during the test period.

4.11 Weight,  $200 \pm 0.2$  g with hook.

4.12 Timing system, for measuring test time in minutes.

4.13 Paper, clean, unprinted, must not have a coating of any kind, for use in adhering fiberboard to panel.

4.14 Razor blade, single edge.

## 5. PROCEDURE A

5.1 Adhere the double-coated tape to the panel with firm finger pressure and remove the liner.

5.2 Lightly sand the backing of the tape on the roll for approximately 250 mm (10'') with 300 grit sandpaper to remove the easy unwind treatment. Start timing with the stop watch. Immediately unwind 300 to 450 mm (12 to 18'') of tape from a freely rotating roll at a rate of 500 to 750 mm/s (20'' to 30''/s).

5.3 Center this strip, adhesive side up, on the panel, aligning the long edges parallel with the panel long edges. Trim to panel dimensions. Do not allow any object to contact the adhesive.

5.4 Place a mask at the center of the specimen so that the 24 mm (1'') dimension of the hole in the mask lies parallel to the long dimension of the specimen edges (see Figure 1). Rub against the mask to assure that the tape specimen is well adhered to the double coated tape on the panel. Avoid touching the adhesive.

5.5 At  $90 \pm 5$  seconds, position the linerboard strip (end opposite the hole) to span the mask and center it lengthwise on the specimen adhesive. Assure that the correct side of the linerboard is placed against the specimen adhesive. Do not apply any finger pressure to the specimen. Continue timing.

5.6 Roll the linerboard against the specimen lengthwise once each way at a rate of 300 mm/min. (12''/min.), using the rubber-covered roller.

5.7 Immediately set the panel, specimen side down, into the test stand, assuring that it will remain in a horizontal plane throughout the test.

5.8 At  $180 \text{ seconds} \pm 5 \text{ seconds}$  (3 minutes from unwinding the tape from the roll), add the 200 g weight so that no shock load is imparted to the linerboard and immediately start the timer. Allow the test to continue until the linerboard has peeled free from the specimen adhesive.

5.9 Void all tests where the tape (test specimen) has pulled away from the panel (either the specimen from the double coated tape or the double coated tape from the panel). When this occurs, repeat the test assuring that the panel, the double-coated tape, and the test specimen are well bonded together.

## 6. PROCEDURE B

6.1 Adhere double coated tape to panel and remove liner.

6.2 Superimpose the fiberboard on the double-coated tape, exposing the correct side and assuring that the machine direction is at a right angle to the long dimension of the panel. Handle the fiberboard only at edges and corners so that an area at least 36 mm (1.5") square at its center is absolutely free of contamination.

6.3 Place a clean sheet of paper (item 4.13) on top of the fiberboard. Rub against this to assure that the fiberboard is well bonded to the double-coated tape on the panel. Do not rub fiberboard surface with the paper or fingers.

6.4 Start timing with stop watch. Immediately unwind 300 to 450 mm (12 to 18") of tape at a rate of approximately 500 to 750 mm/s (20 to 30"/s).

6.5 From the center of this strip cut specimen  $24 \pm 0.25$  mm ( $1.0 \pm 0.01$ ") wide and at least 168 mm (7") in length. Handle this strip by its ends only. Do not allow adhesive to contact any object.

6.6 Lay the specimen, adhesive side up, on the work bench and tape the ends down to hold specimen flat.

6.7 Apply a mask at one end of the specimen so that the 24 mm (1") dimension of the hole lies parallel to the specimen's long edges (see Figure 2).

6.8 Cut away the taped end of the specimen at the mask.

6.9 Apply chipboard square to exposed adhesive at end of specimen. Punch hole for attaching hook of weight.

6.10 At  $90 \pm 5$  seconds position the specimen lengthwise on the fiberboard, adhesive side down, so that the 24 x 24 mm (1" by 1") adhesive area is approximately centered on the fiberboard. Do not apply any finger pressure to specimen. Continue timing.

6.11 Roll specimen lengthwise once in each direction at a rate of 300 mm/min. (12"/min.) using the rubber-covered roller.

6.12 Immediately set the panel, specimen side down, into the test stand assuring that it will remain in a horizontal plane throughout the test.

6.13 At  $180 \pm 5$  seconds (a total of 3 minutes from unwinding the tape from the roll), add the 200 g weight so that no shock load is imparted to the specimen and start timers. Allow test to continue until the specimen has peeled free from the fiberboard (see Figure 3).

6.14 Void all tests where fiberboard has pulled away from the panel (either the fiberboard from the double-coated tape or the double-coated tape from the panel). When this occurs, repeat test assuring that the panel, double-coated tape, and the fiberboard are well bonded together.

## 7. CALCULATIONS

7.1 To determine the final test result for the roll of tape under consideration, take an average of the individual test results and calculate the standard deviation. Individual test values should be recorded. The average of the individual results and the standard deviation is considered the test result. No single specimen value shall be considered as representative of the roll under test.

## 8. REPORT

8.1 The report shall include the following:

8.1.1 Identification of tape tested.

8.1.2 Fiberboard identification.

8.1.3 Anomalous behavior during the test, i.e., adhesive transfer or splitting, paper fiber pulled free from fiberboard, delamination of fiberboard.

8.1.4 The mean time value calculated in section 7.

8.1.5 Which procedure was used.

Another method for measuring adhesion of pressure sensitive tape to fiberboard at 90° angle and constant stress is ASTM D 2860.

<sup>1</sup>The linerboard accepted as the standard test surface, Standard Reference Material 1810A, is available from the Office of Standard Reference Materials, National Institute of Standards and Technology, Washington, D.C. 20234.

---

## SUMMARY OF CHANGES

- Clarified definition in section 1.1.
- Made consistent metric references of 24 mm and 48 mm for standard 1" and 2" tape rolls.

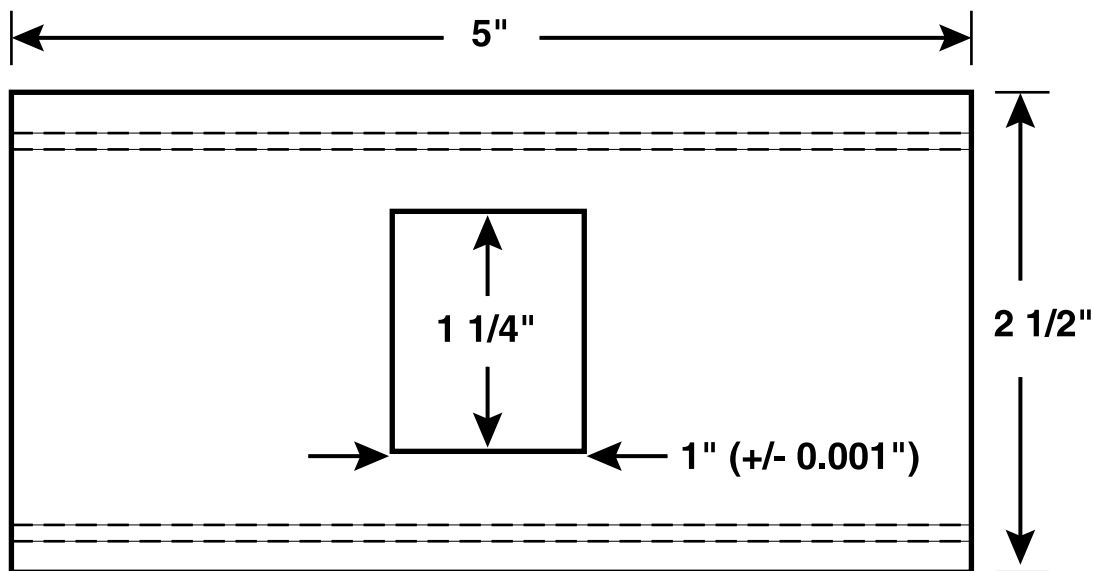

Figure 1. Procedure A test construction.



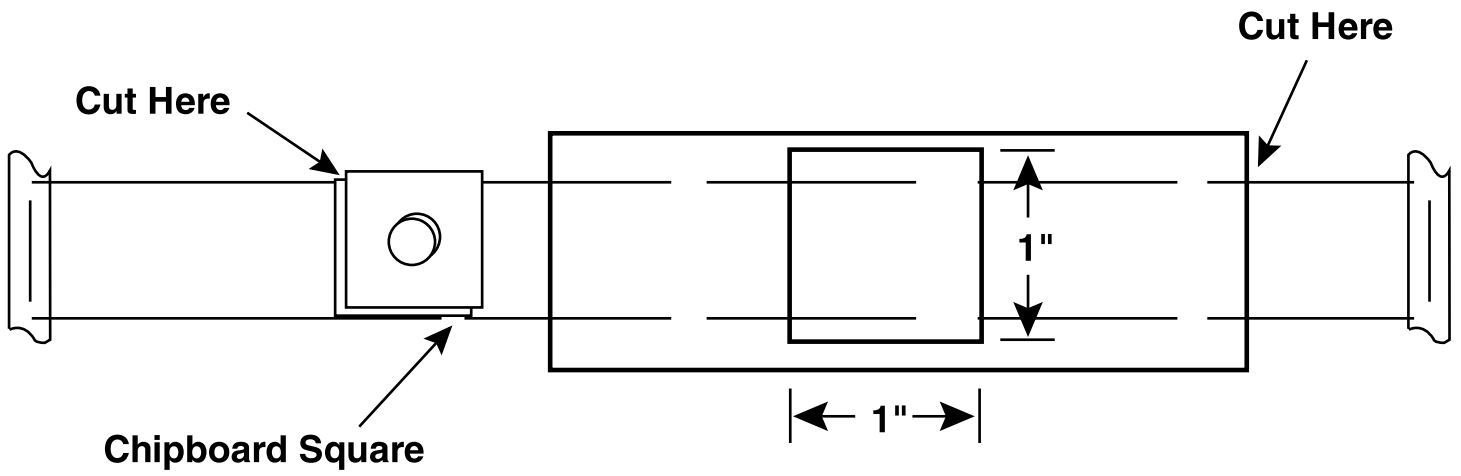

Figure 2. Procedure B test construction.

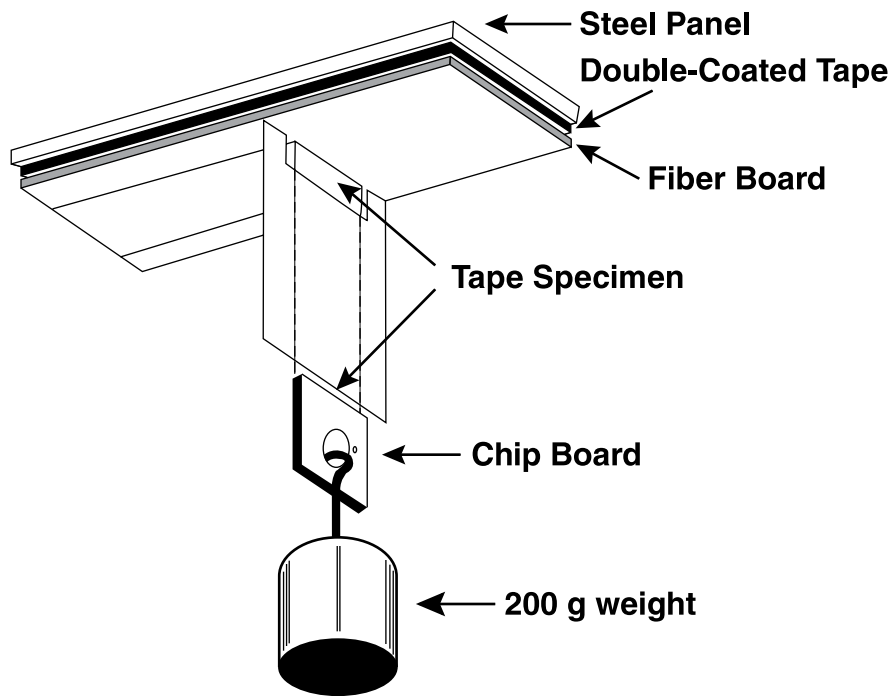

Figure 3. Test construction for adhesion of pressure sensitive tapes to linerboard.



Call Letters	PSTC-16
Date of Issuance	10/00
Revised	10/03
Revised	05/07

# Loop Tack

## 1. SCOPE

1.1 This test method is intended to determine the tack properties of a pressure sensitive adhesive. This test method is applicable to those adhesives that form a bond of measurable strength rapidly upon contact with another surface. Tack force may be measured as the force required to separate the adhesive from the adherend at the interface shortly after they have been brought into contact under a load equal only to the weight of the pressure sensitive article (e.g., tape, label, sticker, etc.) on a one square inch contact area.

1.2 The following test methods are included:  
 Test Method A (using tensile tester)  
 Test Method B (using loop tack tester)

1.3 The values stated in Newtons per 10 mm of width are to be regarded as the standard. The values given in parentheses are for information purposes only.

## 2. SUMMARY OF TEST METHODS

2.1 These methods involve allowing a loop of pressure sensitive adhesive with its backing to be brought into controlled contact with a 24 mm x 24 mm (one square inch) surface of stainless steel, with the only force applied being the weight of the pressure sensitive article itself. The pressure sensitive article is then removed from the substrate, with the force to remove the pressure sensitive article from the adherend measured by a recording instrument.

2.2 Test Method A (using a tensile tester) applies when a tensile tester is used to measure loop tack and involves the use of a loop prepared from a 175 mm (7") specimen strip.

2.3 Test Method B (using a loop tack tester) applies when a loop tack tester is used to measure loop tack and involves the use of a loop prepared from a 125 mm (5") specimen strip.

## 3. SIGNIFICANCE AND USE

3.1 These test methods provide a quantitative measure of the tack property of a pressure sensitive adhesive.

3.2 These test methods are designed to measure the tack property of the adhesive mass. The tack of a given adhesive may vary depending on the backing (generally a stiffer backing leads to higher values).

3.3 These test methods are suitable for quality control, quality assurance and research purposes.

3.4 Test Method A (using a tensile tester) makes use of a specimen strip 175 mm (7") in length.

3.5 Test Method B (using a loop tack tester) makes use of a specimen strip 125 mm (5") in length. That is the only specimen strip that fits properly in the loop tack tester.

3.6 If the adhesive is not already coated onto a backing, these test methods incorporate the use of a clear nominal 50 micron (2 mil) PET film backing for specimen preparation. Use of other backing materials will change performance of the specimen to be tested.

A Summary of Changes section appears at the end of this test method.

3.7 If the sample is a double-coated product, laminate a piece of nominal 50 micron (2 mil) PET to the side not being tested. If the product is an unsupported product, laminate a piece of nominal 50 micron (2 mil) PET to the non-liner side.

## **TEST METHOD A (USING TENSILE TESTER)**

### **4. APPARATUS - See Appendix B**

4.1 Tensile tester - A constant rate of extension type.

4.2 Test fixture (Figure 3 - 5) - To be mounted into the jaws of the tensile tester. A panel held by the test fixture allows for a 625 sq mm (one square inch) contact area of the pressure sensitive adhesive article. Alternately, the test fixture may include a raised area that allows a 625 sq mm (one square inch) contact area of the pressure sensitive article.

4.3 Apparatus for cutting

4.3.1 Die cutter - A 24 mm x 175 mm (1" x 7") rectangular mallet-type die cutter with mallet, or use a clicking press cutter with corresponding die of equivalent dimension, for sample preparation.

4.3.2 If a fixed dimension die is unavailable, substitute a 24 mm (1") steel bar with a double razor knife or other apparatus suitable for cutting the specimen into the specified dimensions to prepare the 24 mm (1") wide specimen strips.

4.4 Absorbent lint-free cleaning wipes - Materials produced from entirely virgin raw materials and containing less than 0.25% by weight of solvent-leachable materials.

4.5 Masking tape - 24 mm (1") wide.

4.6 50 microns (2 mil) polyester film (PET) - To be used as a support medium in evaluating unsupported adhesives such as transfer tapes, laminating adhesives, or other film free adhesives.

4.7 Reagents - Appropriate reagents include acetone, methyl ethyl ketone, diacetone alcohol, n-heptane and toluene, reagent or analytical grade, or an ethanol cleaner for water-based adhesives.

### **5. SAMPLE PREPARATION**

5.1 Cut sample into 24 mm x 175 mm (1" x 7") specimen strips in the machine direction of the pressure sensitive article. Use of strips with other lengths may change the results. Cut at least three specimen strips for each adhesive to be tested.

5.2 Condition specimens to be tested for at least 24 hours in the testing room at  $23 \pm 2^{\circ}\text{C}$  ( $73.4 \pm 3.6^{\circ}\text{F}$ ) and a relative humidity of  $50 \pm 5\%$  prior to conducting the test.

### **6. PROCEDURE**

#### **TEST METHOD A (USING TENSILE TESTER)**

6.1 Ensure the tensile tester is calibrated according to instructions supplied by the manufacturer.

6.2 Set instrument crosshead speed at 300 mm (12 inches) per minute.

6.3 Place the test fixture in the lower grip of the tensile tester. It is important that the test fixture be level and straight in the lower grip. (See Figure 2 and 4.) Set gaps for the crosshead using the minimum and maximum gap setting on the extension cycle. Set gaps  $24 \text{ mm} \pm 1 \text{ mm}$  ( $1" \pm 0.05"$ ) (critical) and  $100 \text{ mm} \pm 3 \text{ mm}$  ( $4" \pm 0.1"$ ) (optional) from the bottom of the upper grips to the face of the stainless steel portion of the test fixture when the test fixture is locked in the lower grips.

6.4 Clean the stainless steel portion of the test fixture (the area the pressure sensitive article will contact) of large amounts of residue using an appropriate reagent from section 4.7. Next clean the panel as per method in Appendix C. Allow 2 minutes to elapse after cleaning to ensure complete evaporation of the cleaning solvent. User must ensure that the cleaning method used removes all residues from the test fixture.

- 6.5 Completely remove the release liner (if the pressure sensitive article normally includes a release liner) from the specimen.
- 6.6 Bend the specimen completely back on itself, being careful not to crease it. The specimen forms a teardrop-shaped loop with the adhesive surface facing out (Figures 1 and 6).
- 6.7 Fasten the ends of the loop together, using a strip of masking tape 24 mm (1 inch) wide. The masking tape covers the ends of the loop, preventing contamination of the grips of the tensile tester.
- 6.8 Insert the tape end of the specimen loop into the upper grips so that the bottom edge of the masking tape is even with the bottom edges of the grips.
- 6.9 Activate the tensile tester so that the crosshead moves downward. The mid-section of the specimen loop must contact the center of the stainless steel portion of the test fixture. When the crosshead reaches its minimum position, it will immediately switch direction and move upward. When the crosshead is at its minimum position, the specimen loop will completely cover the 1 square inch (645 square mm) area of the stainless steel portion of the test fixture without excessive “hang-over” of the edges.

NOTE: If tensile tester does not have automatic cycling, cycling must be done manually.

6.10 Record the maximum force required to remove the specimen loop from the stainless steel portion of the test fixture as well as the mode of failure.

6.10.1 Record the failure mode as adhesive failure, cohesive failure or adhesive transfer.

6.11 Repeat the procedure at least two additional times for each adhesive to be tested (for a minimum of three replicates). Use a fresh specimen strip for each test.

6.12 When testing is complete, clean the stainless steel portion of the test fixture with approved reagent. Cover with surface protective tape when not in use to protect surface from scratches.

## **TEST METHOD B (USING LOOP TACK TESTER)**

### **7. APPARATUS**

7.1 Loop tack tester (Figure 5).

7.2 Stainless steel test panels - 24 mm x 150 mm (1" x 6"), stainless steel as specified in ASTM Specification A 666. See PSTC-101 section 5.3.

7.3 Apparatus for cutting.

7.3.1 Die cutter - A 24 mm x 125 mm (1" x 5") rectangular mallet-type die cutter with mallet for sample preparation.

7.3.2 If a fixed dimension die is unavailable, substitute a 24 mm (1") steel bar with a double razor knife or other apparatus suitable for cutting the specimen into the specified dimensions to prepare the 24 mm (1") wide specimen strips.

7.4 Absorbent lint-free cleaning wipes - Materials produced from entirely virgin raw materials and containing less than 0.25% by weight of solvent-leachable materials.

7.5 Masking tape - 12 mm (0.5") wide.

7.6 A nominal 50 micron (2 mil) PET film - To be used as support medium in evaluating unsupported adhesives such as transfer tapes, laminating adhesives, or other free film adhesives.

7.7 Reagents - Appropriate reagents include acetone, methyl ethyl ketone, diacetone alcohol, n-heptane and toluene, reagent or analytical grade, or an ethanol cleaner for water-based adhesives.

## 8. SAMPLE PREPARATION

8.1 Cut sample into 24 mm x 125 mm (1" x 5") specimen strips in the machine direction of the pressure sensitive article. Use of strips of other lengths may change results and will not fit properly in the loop tack tester. Cut at least three specimen strips for each adhesive to be tested.

NOTE: If transfer or unsupported adhesives are to be tested, these are to be laminated to a nominal 50 micron (2 mil) PET film, used as an adhesive support, prior to cutting the samples into the 24 mm x 125 mm (1" x 5") specimen strips.

8.2 Condition specimens to be tested for at least 24 hours in the testing room at  $23 \pm 2^{\circ}\text{C}$  ( $73.4 \pm 3.6^{\circ}\text{F}$ ) and a relative humidity of  $50 \pm 5\%$  prior to conducting the test.

## 9. PROCEDURE

9.1 Ensure that the loop tack tester is leveled.

9.2 Clean the stainless steel panel of large amounts of residue using an appropriate reagent from section 4.7. Next clean the panel as per method in Appendix C. Use a separate piece of cleaning wipe each time. Repeat for a total of three washes after the test panel appears clean. Allow two minutes to elapse after cleaning to ensure complete evaporation of the cleaning solvent. User must ensure that cleaning method used removes all residue from the old test fixture.

9.3 Insert the test panel and tighten the four clamp screws.

9.4 Completely remove the release liner (if the pressure sensitive article normally includes a release liner) from the specimen.

9.5 Bend the specimen completely back on itself, being careful not to crease it. The specimen forms a teardrop-shaped loop with the adhesive surface facing out (Figures 1 and 6).

9.6 Fasten the ends of the specimen loop together, using a strip of masking tape 12 mm (0.5 inch) wide.

9.7 Insert the specimen loop into the specimen jaw until it touches the guide pins near the center of the jaw. Inserting the specimen loop in this way ensures that it is positioned properly. Ensure that the grip is in its upward most position.

9.8 Zero the force gauge according to instructions provided by the manufacturer.

9.9 Activate the loop tack tester. The upper assembly will complete one full cycle and automatically shut off when the force gauge again reaches its starting position.

9.9.1 This cycle will first move the upper assembly downward, bringing the specimen loop into contact with the test surface, forming a bond.

9.9.2 The assembly will then move upward and the force gauge measures the force required to break the bond.

9.9.3 The cycle will end when the assembly returns to its original starting position.

9.10 Record the maximum force required to remove the specimen loop from the stainless steel panel as well as the mode of failure.

9.10.1 Record the failure mode as adhesive failure, cohesive failure or adhesive transfer.

9.11 Repeat procedure at least two additional times for each adhesive to be tested (for a minimum of three replicates). Use a fresh specimen strip for each test.

9.12 When testing is complete, clean the stainless steel panel with approved reagent from section 4.7. Cover with surface protection tape when not in use to protect the surface from scratches.

## **10. CALCULATION**

10.1 Calculate the average peak reading in Newtons/10 mm (pounds/inch) using at least three specimens for each adhesive.

## **11. REPORT**

11.1 Report the following:

11.1.1 Test Method A or B.

11.1.2 Identification of the adhesive.

11.1.3 Reagent(s) and method used for cleaning the stainless steel portion of the test fixture.

11.1.4 Conditioning time for prepared specimens.

11.1.5 Adhesive type and coating thickness in mm (mils).

11.1.6 Backing material used for the adhesive.

11.1.7 Release liner used, if any.

11.1.8 Temperature and humidity conditions.

11.1.9 Average peak reading in Newtons/10 mm (pounds/inch).

11.1.10 Visual failure mode as adhesive failure, cohesive failure or adhesive transfer.

11.1.11 Length of the specimen strip in mm (inches).

## **12. KEYWORDS**

12.1 Adhesive; loop tack; pressure sensitive article; tack.

---

## **SUMMARY OF CHANGES**

- Made consistent metric references of 24 mm and 48 mm for standard 1" and 2" tape rolls.

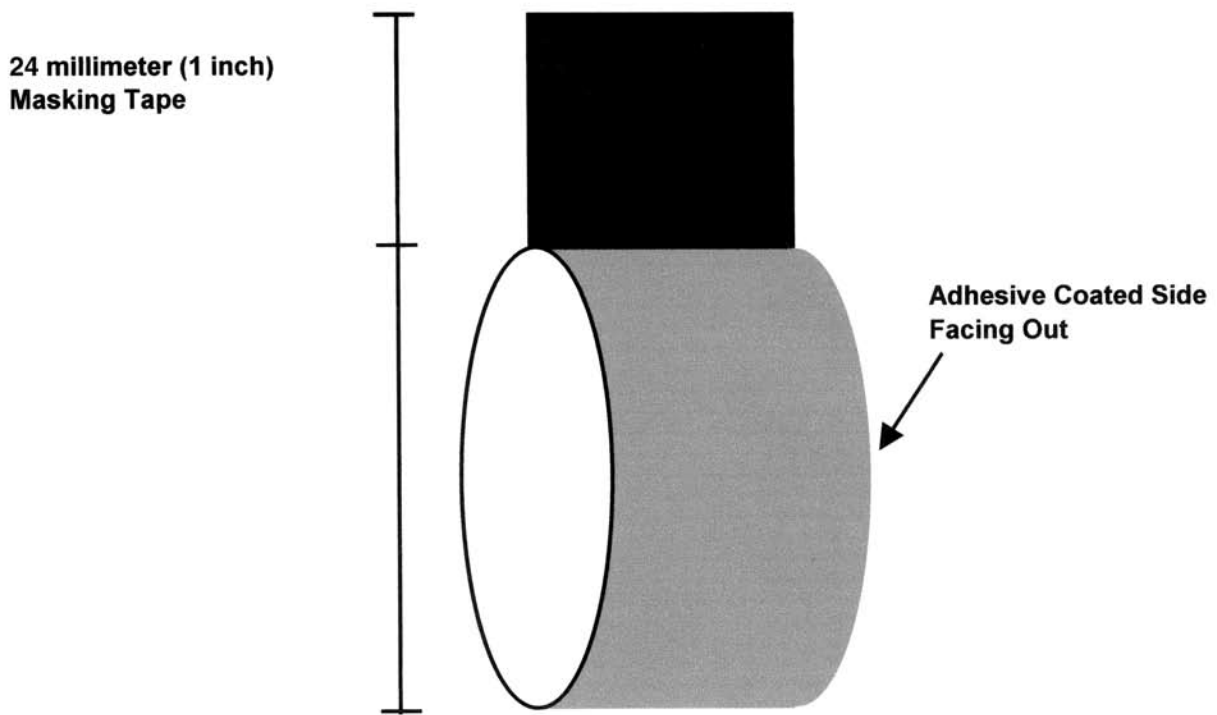

Figure 1. Specimen loop - Test Method A.

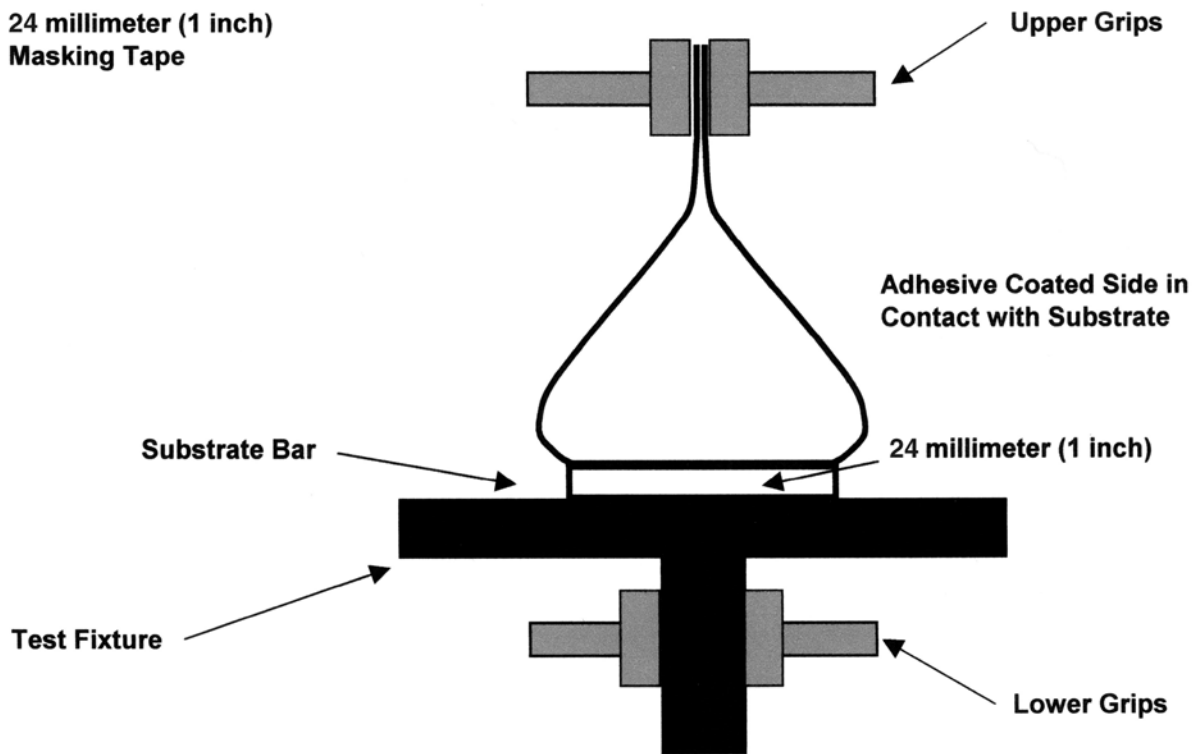

Figure 2. Loop tack sample during test.



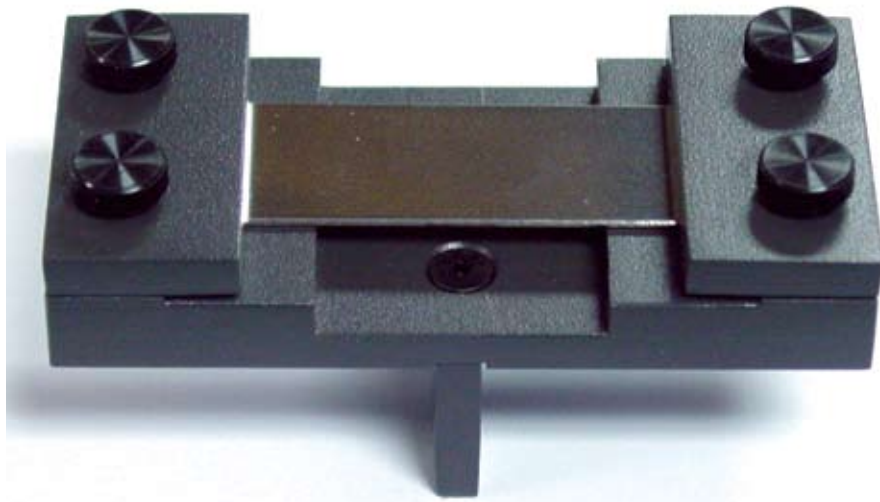

Figure 3. Loop tack tensile fixture - rotated view.



Figure 4. Tensile fixture mounted in tensile tester.



Figure 5. Loop fixture mounted in loop tack tester.



Figure 6. Creating loop specimen.

Call Letters	PSTC-21
Date of Issuance	02/59
Revised	08/85
Revised	08/89
Revised	06/00
Revised	10/03
Revised	05/07

## Stain Test for Finishes

### 1. DEFINITION

1.1 Paint staining is the discoloration of a painted surface that may result from a pressure sensitive adhesive tape being in contact with that surface. (It is not to be confused with that discoloration of the untaped area which may result when exposed to elevated temperatures or ultraviolet light.)

### 2. SIGNIFICANCE

2.1 Paint staining is an important property determination if a tape is to be applied to a painted surface wherein any resulting discoloration is undesirable.

### 3. SCOPE

3.1 To provide the user with a general method of testing a tape for paint staining characteristics. Because of the many types of paints and their conditions of drying or baking, this test must be adapted to the specific paint and conditions with which the user is concerned.

### 4. TEST SPECIMEN

4.1 Discard at least three, but no more than six, outer wraps of tape from each roll being tested prior to taking test specimens.

4.2 All specimens shall be of equal dimensions sufficient in size to give good comparison between the area covered by the specimen and that not covered, preferably 12 mm wide by 48 mm long (1/2" wide by 2" long).

### 5. EQUIPMENT AND MATERIAL

5.1 The test panels shall be plain flat metal, or plate glass, of convenient size preferably 100 mm x 100 mm (4 x 4") square and of any convenient thickness.

5.2 Standard paint spray equipment or other suitable means of applying a uniform paint film.

5.3 Test oven shall be reliable convection or forced-circulation type, of sufficient size to accommodate the test panels and capable of maintaining, within  $\pm 2^{\circ}\text{C}$  the temperature conditions of drying or baking under which the paint and tape will be used.

5.4 A 2 kg (4 1/2 lb.) rubber-covered roller, as described in Appendix B.

5.5 The paint shall be of the same type as that being used in the specific field application.

### 6. TEST METHOD

6.1 Using standard spraying technique or other method, coat a test panel with the paint to be used to obtain a dry film thickness of 37.5 to 50 microns. A primer coat may be necessary to obtain sufficient bond to the test panel.

6.2 Allow the coated panel to air dry for 30 minutes at standard conditions of  $23^{\circ}\text{C} \pm 2^{\circ}\text{C}$ ,  $50\% \pm 5\%$  RH. See Appendix A.

6.3 After this preliminary dry, expose the test panel to the time and temperature recommended by the paint manufacturer, or as set up by the user, to obtain a satisfactory finish.

A Summary of Changes section appears at the end of this test method.

6.4 After allowing the panel to return to room temperature, apply the tape specimens to be tested, including an accepted standard or control (no more than four strips per panel) so that each strip extends radially from the center towards a corner, as indicated in Figure 1.

6.5 Roll down each strip manually with the 2 kg (4 1/2 lb.) roller, three times in each direction at a rate of 150 to 300 mm/s (6 to 12"/s).

6.6 Re-expose the test panel - so prepared, to the same conditions as specified in 6.3 above.

6.7 At room temperature, after the above exposure, strip off specimens and clean the panel using naphtha or other suitable solvent to remove any adhesive residue. It is advisable to reapply the stripped specimens on the reverse side of the panel, in order to retain their identity.

6.8 Examine panel for staining in the areas of tape application.

## **7. REPORT**

7.1 Using a relative numerical rating scale, record for each specimen its relative degree of stain, including a brief qualitative description of the stain.

°This specifically described procedure is considered to be necessary in order to neutralize any effects of optical illusion that are known to occur and interfere with a correct interpretation of test results.

---

## **SUMMARY OF CHANGES**

- Made consistent metric references of 24 mm and 48 mm for standard 1" and 2" tape rolls.

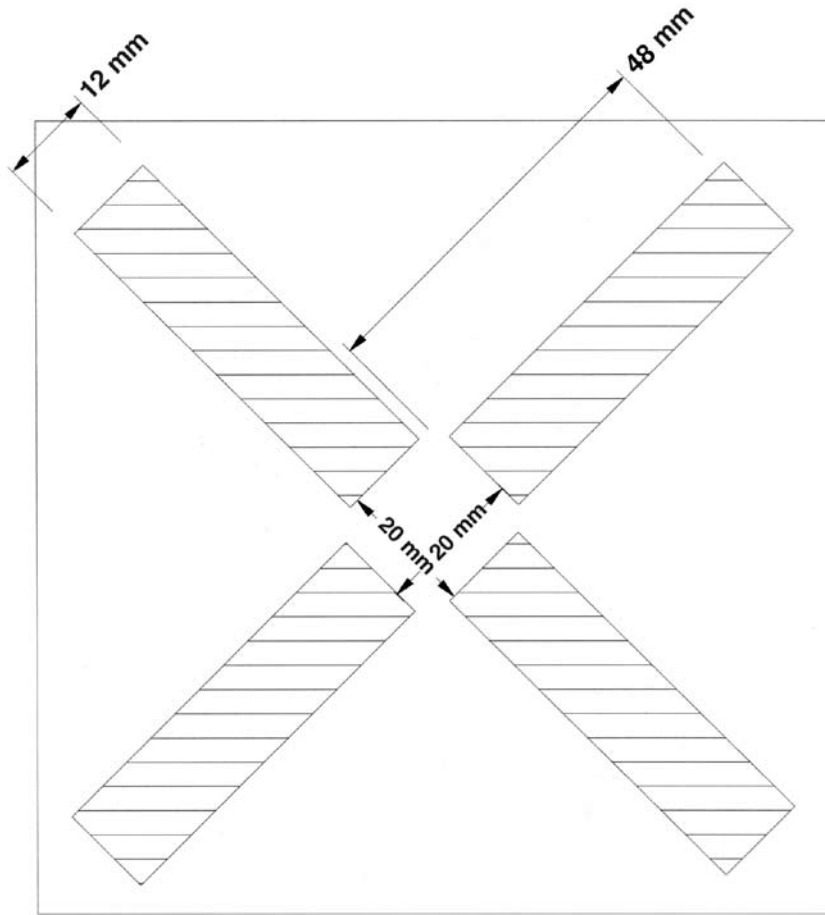

Figure 1. Stain test panel.

Call Letters	PSTC-22
Date of Issuance	06/61
Revised	08/85
Revised	08/89
Revised	06/00
Revised	10/03
Revised	05/07

## Latent Staining of Surface Finishes

### 1. DEFINITION

1.1 Latent staining of a surface finish is the discoloration of that surface that has been in contact with a pressure sensitive tape, but that makes its appearance some time after the tape has been removed.

### 2. SIGNIFICANCE

2.1 Latent staining is an important property determination if a tape is to be applied to a surface finish wherein any resulting discoloration occurring some time after removal of the tape is undesirable.

### 3. SCOPE

3.1 To provide the user with a method of testing a tape for latent staining characteristics. Because of the many types of surface finishes, this test must be adapted to the specific finish with which the user is concerned.

### 4. TEST SPECIMEN

4.1 Discard at least three, but no more than six, outer wraps of tape from each roll being tested prior to taking test specimen.

4.2 Each specimen shall be equal in dimensions to the others, sufficient in size to give good comparison of the area covered by the specimen to that not covered, preferably 12 mm wide x 48 mm long (1/2" wide by 2" long).

### 5. EQUIPMENT AND MATERIAL

5.1 The test panels shall be plain flat metal, or plate glass, of convenient size, preferably 100 mm (4") square, and of any convenient thickness.

5.2 Standard spray equipment or other suitable means of applying a uniform surface finish.

5.3 Test oven which shall be reliable convection or forced-circulation type, of sufficient size to accommodate the test panels and capable of maintaining, within  $\pm 2^\circ\text{C}$ , the temperature conditions of drying or baking recommended by the manufacturer of the surface finish.

5.4 A 2 kg (4 1/2 lb.) rubber-covered roller as described in Appendix B.

5.5 Ultraviolet light source (RS lamp, preferably mounted in an enclosed space 600 x 600 x 900 mm (24 x 24 x 36") high, open at the top so that the bottom of the lamp is 450 mm (18") above the test platform).<sup>1</sup>

5.6 One thin flat metal template, 62.5 mm (2 1/2") square.

5.7 The surface finish shall be of the same type as that being used in the specific field application.

## 6. TEST METHOD

6.1 Using standard spraying technique or other method, coat a test panel with the paint to be used to obtain a dry film thickness of 37.5 to 50 microns. A primer coat may be necessary to obtain sufficient bond to the test panel.

6.2 Allow the coated panel to air dry for 30 minutes at standard conditions of  $23^{\circ}\text{C} \pm 2^{\circ}\text{C}$ ,  $50\% \text{ RH} \pm 5\%$ . See Appendix A.

6.3 After this preliminary dry, expose the test panel to the time and temperature recommended by the paint manufacturer, or as set up by the user, to obtain a satisfactory finish.

6.4 After allowing the panel to return to room temperature, apply the tape specimens to be tested, including an accepted standard or control (no more than four strips per panel) so that each strip extends radially from the center towards a corner,<sup>2</sup> as indicated in Figure 1.

6.5 Roll down each strip manually with the 2 kg (4 1/2 lb.) roller, three times in each direction at a rate of 150 to 300 mm/s (6 to 12"/s).

6.6 Re-expose the test panel, so prepared, to the same conditions as specified in 6.3 above.

6.7 At room temperature, after the above exposure, strip off specimens and clean the panel, using naphtha or other suitable solvent to remove any adhesive residue. It is advisable to reapply the stripped specimens on the reverse side of the panel, in order to retain their identity.

6.8 Examine panel for staining in the areas of tape application.

6.9 Using the 70 mm (2 3/4") square template, block off the central test surface of the panel so that its diagonals are at a 45° angle to the diagonals of the test panel and place the assembly, face up, in the ultraviolet light enclosure for a period of 4 hours. Avoid excessive heating, a maximum of 57°C is recommended.

## 7. REPORT

7.1 Using a relative numerical rating scale, record for each specimen its relative degree of stain for both oven exposure and, where applicable, ultraviolet light exposure, including a brief qualitative description of the stain.

<sup>1</sup>The intensity of an RS lamp ultraviolet source decreases as the number of hours of use accumulate. It is recommended that such a lamp not be used beyond the time limit set by its manufacturer. For this reason, it is also mandatory that a standard or control specimen be included on every panel.

<sup>2</sup>This specifically described procedure is considered to be necessary in order to neutralize any effects of optical illusion which are known to occur and interfere with a correct interpretation of test results.

---

## SUMMARY OF CHANGES

- Made consistent metric references of 24 mm and 48 mm for standard 1" and 2" tape rolls.

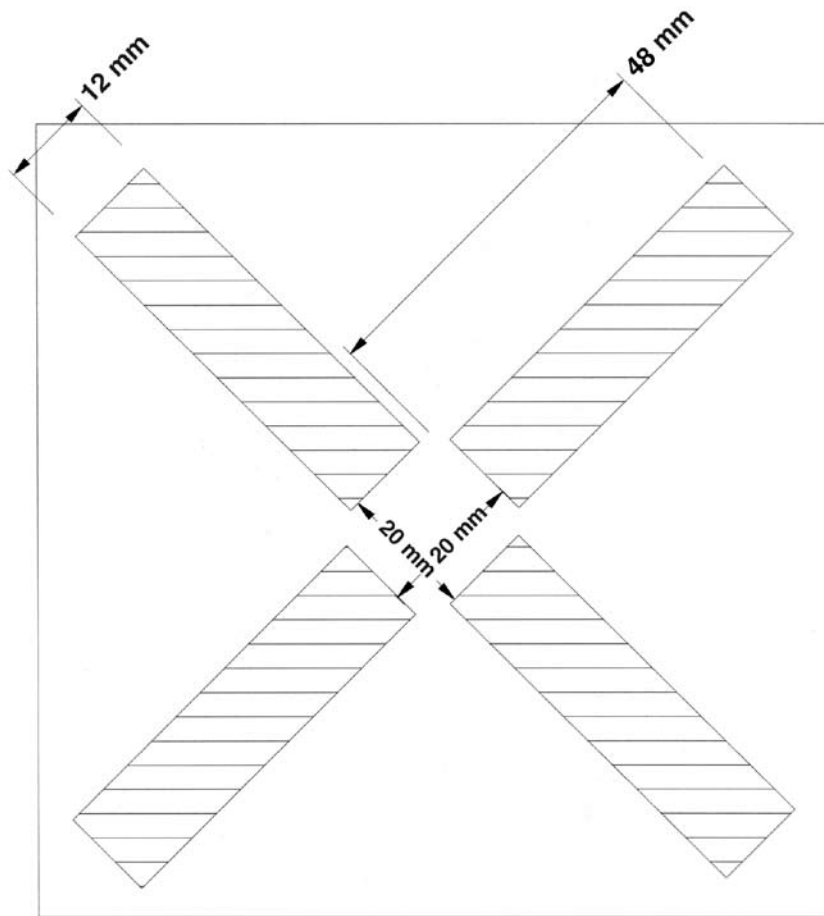

Figure 1. Stain test panel.



Call Letters	PSTC-131
Date of Issuance	09/55
Revised	04/66
Revised	11/70
Revised	08/85
Revised	08/89
Revised	06/00
Revised	10/03
Revised	05/07

## Breaking Strength and Elongation of Pressure Sensitive Tapes

### 1. SCOPE

1.1 The procedures in this test method describe the measurement of breaking strength, elongation at break, and energy to break, of pressure sensitive tapes.

1.1.1 Test Procedure A gives the breaking strength and elongation of tapes having 200% or less elongation, other than filament reinforced tapes.

1.1.2 Test Procedure B gives the breaking strength and elongation of filament reinforced tapes.

1.2 These procedures provide a means of assessing the uniformity of breaking strength and elongation of a given type of pressure sensitive tape. The assessment may be within a roll of tape, between rolls or between production lots.

1.3 This test method may be used in comparing one product with another.

Afera: Association des Fabricants Europeens de Rubans Auto-Adhesives (Association of European Tape Manufacturers)

ASTM: American Society for Testing and Materials (USA)

EN: European Norm (Europe)

PSTC: Pressure Sensitive Tape Council (North America)

### 2. REFERENCED DOCUMENTS

#### 2.1 ASTM Standards

2.1.1 D 3759/D 3759M Test Method for Breaking Strength and Elongation of Pressure Sensitive Tape.

#### 2.2 AFERA Standards

2.2.1 AFERA 5004 Test Method for Breaking Strength and Elongation of Pressure Sensitive Tape

#### 2.3 European Norm (EN) Standards

2.3.1 EN 14410 – Self Adhesive Tapes - Measurement of Breaking Strength and Elongation at Break

#### 2.4 PSTC Standards

2.4.1 PSTC 131 replaces PSTC 31.

### 3. SUMMARY OF TEST METHOD

3.1 Procedure A – Tapes with elongation under 200% – A strip of tape is mounted between two clamps aligned in a straight flat plane and force applied at a specified rate until breaking of the strip of tape occurs. Elongation is determined at moment of breakage.

A Summary of Changes section appears at the end of this test method.

3.2 Procedure B – Filament reinforced tape – A strip of tape is applied to two drums aligned in a flat plane and force applied until breakage of tape occurs. Elongation is determined at the moment of breakage.

#### **4. SIGNIFICANCE AND USE**

4.1 This test method provides information that can be used in material specification for product design and quality assurance applications. It can be used in comparing different products.

4.2 The use of this test method must be related to the purpose for which the test is performed. One purpose is for determining the relative strength of the tape in the size in which it is purchased or used. Another purpose is to identify or characterize a particular backing material.

4.2.1 When relative strength is of interest, the test should be performed on the tape-as-received, that is, without cutting the material to a specimen width less than the as-received width.

4.2.1.1 Usually tapes wider than 24 or 25 mm are not tested due principally to the limitation of equipment. Tapes as narrow as 3 mm can be tested.

4.2.1.2 Comparison of materials by different procedures should be avoided because test parameters of specimen dimensions and crosshead velocity determine outcome. Changes in the parameter levels will produce different results for the same material.

Note 1: It is usual to find breaking strength increasing significantly with increasing crosshead velocity.

4.2.2 When identity of material characterization is of interest, the test method should be performed on a specimen cut from within the sample material boundaries using a sharp razor cutter, such as defined in section 5.

Note 2: Some of the traditional tools for specimen preparation must be avoided when backing is comprised of thin plastic sheeting. These include chopping dies and sample cutters operating on a shearing principle. The reason for this restraint is that edges sufficiently ragged and damaged resulting from shearing or chopping can cause tearing to occur before the true breaking strength level is reached. Tapes with fibrous backings may be cut to satisfactory specimens with these tools.

Note 3: Elongation measurements become difficult to perform on stretchy materials (greater than 200% ultimate elongation) when the ratio of specimen length to width is small (approaching 2). The results show high variability and do not allow for practical use of this information except when one wishes to demonstrate large differences between materials.

#### **5. APPARATUS - See Appendix B**

5.1 Tension tester - A constant-rate-of-extension (CRE) type with a capacity such that the maximum expected specimen strength does not exceed 90% of its normal limit. The tester shall have two clamps with centers in the same plane, parallel with the direction of the motion of the stressing clamp, and so aligned that they will hold the specimen wholly in the same plane; a means of moving the stressing clamp at a uniform rate of  $5.0 \pm 0.2$  mm/s and a device for recording the load. The instrument shall be calibrated to an accuracy of 0.5% of a full scale and the scale used for any test shall be such that the test level falls within 20% to 80% of full scale.

5.1.1 Test information should be recorded by such a means that it will be available for use during calculations (see Section 11).

5.1.2 Clamps, preferably the pneumatic action type.

5.1.2.1 Clamp faces at least 50 mm wide by 38 mm deep. Faces shall have a light crosshatch serration.

Note 4: Plastic materials are reduced in width and thickness while being stretched. This causes them to draw down out of the clamps. Pneumatic clamps minimize this effect. It can be further reduced by the appropriate choice of surface of the clamps. The greatest improvement, both with respect to the above mentioned shrinkage problem and simple slippage, may be found from the use of urethane film, which can be obtained as a pressure sensitive tape approximately 0.5 mm thick. This material has a very high coefficient of friction, is somewhat malleable and is easily replaced. Alternative materials are coated abrasive, rubber (neoprene or other synthetic types) or other tapes.

Note 5: The use of clamps for testing a reinforced tape is discouraged because the strength of reinforced tapes requires excessive clamping pressure, which can cause crushing of the reinforcing filaments. When this occurs, the tape usually breaks at the jaw edge, which can result in lower breaking values. Hence the use of cylinders described in 5.1.3 is recommended for reinforced tapes.

5.1.3 Cylinders, in place of clamps for testing reinforced tapes. Each of two cylinders shall be approximately 100 mm in diameter and approximately 38 mm wide, held in the position ordinarily occupied by the clamps so that the tape, when applied to the cylinders and extended between them falls in the line of stress otherwise occupied by the specimens when clamps are used. See Figure 1.

5.1.4 Scale, approximately 22 mm in length divided into 2 mm increments attached to each cylinder. The zero point (origin) shall be at the point of tangency of the tape with the cylinder during test and the scales shall increase upward on the lower cylinder and downward on the upper cylinder.

Note 6: These scales shall be used to observe and measure the tape slippage during breaking strength test of reinforced tapes.

5.2 Specimen cutter - The specimen cutter shall hold two single edge razor blades in parallel planes, a precise distance apart, to form a cutter of exact specimen width. Two cutters, 12 and 24 mm cutting width, shall be available. Appropriate alternates, which will not cause edge damage, may be used.

5.2.1 The 12 mm cutter shall consist of a 12 mm thick by approximately 200 mm length of aluminum bar stock. The edges, for 125 mm from one end, slightly rounded to form a handle. The width of the bar, for approximately 75 mm from the opposite end, shall be narrowed to exactly 12 mm minus the thickness of a single razor blade (one of two used as cutting edges). The razor blades shall be held in position using side plates. The end of the cutter shall be cut away at 45° angle to expose the cutting edges at one end of the blade. The edges shall be separated by  $12 \pm 0.10$  mm. The 24 mm cutter shall follow the same description except the bar stock shall be 24 mm and shall be narrowed exactly to 24 mm minus the thickness of a single edge razor blade.

## 6. SAMPLING

6.1 Sampling shall be in accordance with Practice D 3715/D 3715M.

6.2 Sampling for other purposes - The sampling and the number of test specimens depends on the purpose of the testing. Practice E 122 is recommended. It is common to test at least five specimens of a particular tape. Test specimens should be taken from several rolls of a tape and, whenever possible, among several production runs of tape. Strong conclusions about a specific property of a tape cannot be based on the test result of a single unit (roll) of product.

## 7. TEST SPECIMENS

7.1 Test specimens shall be no less than 3 mm or more than 24 mm wide, except that 25 mm widths may be used when supplied. Length shall be 200 mm for non-reinforced tapes and 700 mm for reinforced tapes.

7.2 Unwind and discard at least three, but no more than six, outer wraps of the tape from the sample roll before taking specimens for testing.

7.3 Test one specimen per roll, unless otherwise specified. More than one test per roll is permitted so that a total of five specimens are tested for each determination.

7.4 For non-reinforced tapes, specimen ends that are clamped shall be prepared by covering the adhesive with paper, some other tape or folded onto itself (folding onto itself requires an extra 100 mm in specimen length).

7.4.1 The covering shall be free of wrinkles, leaving the gauge-length area uncovered and shall completely cover the rest of the specimen so that the clamps will apply uniform pressure to the specimen.

7.5 For reinforced tapes the specimen requires no further preparation other than to have the appropriate dimensions and to ensure that the adhesive is not contaminated so it will adhere to the cylinders.

## **8. PREPARATION OF APPARATUS**

8.1 For non-reinforced tapes, set the gauge length at 100 mm.

8.2 For reinforced tapes, set the cylinders 150 mm apart so that at the start of the test, 250 mm of tape will extend between and without contact with the cylinders.

Note 7: The upper cylinder should be counter-balanced in order that the line of tape contact on the cylinder intersects an imaginary line running between the points of cylinder attachment to the tester and not side forces are exerted during the test. See Figure 1.

## **9. CONDITIONING**

9.1 Condition the sample rolls of tape in the standard conditions per Appendix A

## **10. PROCEDURE**

10.1 Procedure A - Non-reinforced tapes with elongation under 200%

10.1.1 Clamp the specimen in the grips of the testing machine. Take care to align the long axis of the specimen with an imaginary line running between points of attachment of the grips and including the center of the grips. Apply no more tension to the specimen during clamping than necessary to remove slack.

10.1.2 Start the crosshead in motion at a rate of  $300 \pm 30$  mm/min. Ensure that the means of recording the data is operating. Continue until the specimen ruptures.

10.2 Procedure B - Filament reinforced tapes

10.2.1 Adhere approximately 230 mm of the specimen on the upper cylinder beginning at the line of tape contact (see 8.2), and wrap the specimen around the surface of the cylinder. Repeat this with the free end of the specimen on the lower cylinder, except wrap the specimen around the bottom surface of the cylinder. The applied specimen must be centered on the centerline around the cylinder surface. This elimination of skewness prevents non-uniform stress loading across the width of the specimen. The specimen shall also be sufficiently taut to remove slack. See Figure 1.

10.2.2 Mark the specimen (and the cylinder if not already done) with a marking pen making a line approximately 1 mm wide at the line where the tape contacts each cylinder. These benchmarks will be 25 mm apart and shall be checked to ensure this.

10.2.3 Start the crosshead in motion at  $300 \pm 30$  mm/min and ensure that the data is being recorded.

10.2.4 Observe the bench marks on the specimen to determine their change in position relative to the marks on the cylinder. Use the scales appended to the cylinders. (See 5.1.4.)

10.2.5 When the specimen breaks, record the sum of the upper and lower bench mark changes to the nearest 2 mm. This will be the correction for the elongation.

10.2.6 Also record the indicated responses for breaking strength and elongation when the tester provides a numerical display of the information.

### 10.3 Breaking energy (optional)

10.3.1 The breaking energy to break is defined by the area under the stress-strain curve to the point of rupture. This is usually integrated electronically or by a commercially available software program.

10.3.2 With homogenous film, foil or paper backed tapes, this value can be normalized as the energy per unit volume of tape backing based on the initial gauge region of the test specimen. This may be reported in mega joules per cubic meter.

10.3.3 The test results can also be normalized to a tape width under these test conditions. This may be reported in joules per 100 mm of width.

## 11. CALCULATION

11.1 Determine the breaking strength at point of break from the recorded data. Express the result in N/10 mm.

### 11.2 Ultimate elongation

11.2.1 For non-reinforced tapes, express the elongation at break as a percentage of the original sample length.

11.2.2 For reinforced tapes, subtract the correction found in 10.2.5 from the elongation at break and express the result as a percentage of the original sample length.

## 12. REPORT

12.1 The report shall include the following.

12.1.1 Statement that this method was used and indicating any deviation from method as written.

12.1.2 Complete identification of each roll tested including tape source, manufacturers' code number and form.

12.1.3 Anomalous behavior during testing.

12.1.4 Report the breaking strength in newtons per 10 mm of width to three significant places.

12.2 Report the ultimate elongation in percent to two significant places.

12.3 Report energy to break (if determined).

12.4 When the desired test response includes ultimate elongation, indicate whether slippage of material within the clamps occurred and estimate the amount.

## 13. KEY WORDS

13.1 Elongation, pressure sensitive tape, breaking strength, tensile strength, energy at break.

## ADDENDUM (Non-Harmonized)

---

### 1. SCOPE

1.1 PSTC 131 has retained procedures for high elongation tapes and cross direction breaking strength and elongation of pressure sensitive tapes, which are not part of the international harmonized test method.

1.1.1 Test Procedure Addendum I, not recognized as part of the international harmonized test method, gives the breaking strength and elongation for high stretch tapes.

1.1.2 Test Procedure Addendum II, not recognized as part of the international harmonized test method, gives the breaking strength and elongation for tapes in the cross direction.

### 2. SUMMARY OF TEST METHOD

2.1 Procedure Addendum I - Tapes with elongation over 200% - A strip of tape is mounted between two clamps aligned in a straight flat plane and force applied at a specified rate until breaking of the strip of tape occurs. Elongation is determined at moment of breakage.

2.2 Procedure Addendum II- Cross direction - A strip of tape is mounted between two clamps aligned in a straight flat plane and force applied at a specified rate until breaking of the strip of tape occurs. Elongation is determined at moment of breakage.

### 3. PROCEDURE

3.1 Procedure Addendum I - Tapes with elongation over 200%

3.1.1 Conduct the test the same as in 10.1 with the following exceptions:

Gauge length	50 mm
Crosshead velocity	50 mm/min
Specimen width	12 mm
Specimen length	150 mm

3.2 Procedure Addendum II - Cross direction

3.2.1 Conduct the test the same as 10.1 with the following exceptions:

Gauge length	25 mm
Crosshead velocity	25 mm/min
Specimen width	12 mm
Specimen length	125 mm

3.2.2 A special specimen preparation is required for cross direction (CD) specimens from rolls of less than 96 mm in width. Lay two rectangular sample strips on a flat surface with the adhesive side facing up (see Figure 2). Each strip shall be as wide as the sample roll and approximately 120 mm in length. Position these strips side by side with one long strip parallel to and 25 mm separated from one long edge of the second strip.

3.2.3 Cut a specimen from the sample roll to have the width specified in section 3.2.1 and length equal to the width of the roll. When identity or material characterization is of interest, the test should be performed on a specimen cut from within the sample material boundaries using a sharp razor cutter.

3.2.4 Lay this specimen adhesive side up across the 25 mm separation of the strips. Position it toward one end of the sample strips so that it rests equally on both strips and at a right angle to their parallel edges.

3.2.5 If needed to prevent slippage, cut two additional extension strips from the sample roll having the same width as the specimen. Butt the end of one of these at one end to form a continuation of the specimen across the remainder of the sample strip. Use the second strip to butt against the other end of the specimen in like manner.

3.2.6 Fold each of the original sample strips over onto itself to form a three-ply tab that will be gripped by the clamps during the test.

3.2.7 Trim off excess (single ply of tape) of either the sample strips or the extension strips extending beyond the two-ply or three-ply parts of the assembly. See Figure 2.

Addendum Note 1: The extension serves to keep the clamping pressure uniform over the whole area of the specimen. This is an imperative factor to a successful test.

---

## SUMMARY OF CHANGES

- Test method title
- Formatted to reflect harmonized method
- Provided addendum for additional procedures that are not a part of the harmonized method
- Updated the figures

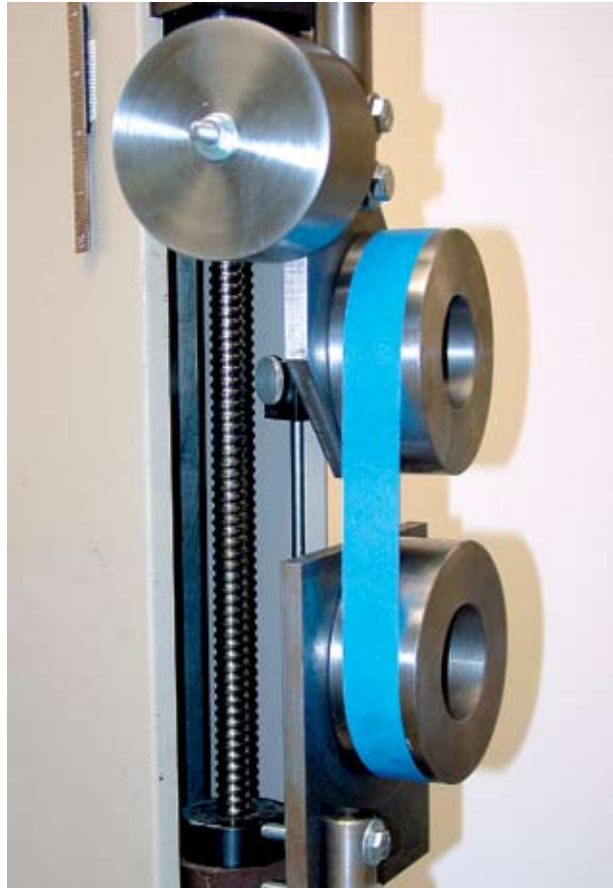

Figure 1. Tensile testing equipment set up.

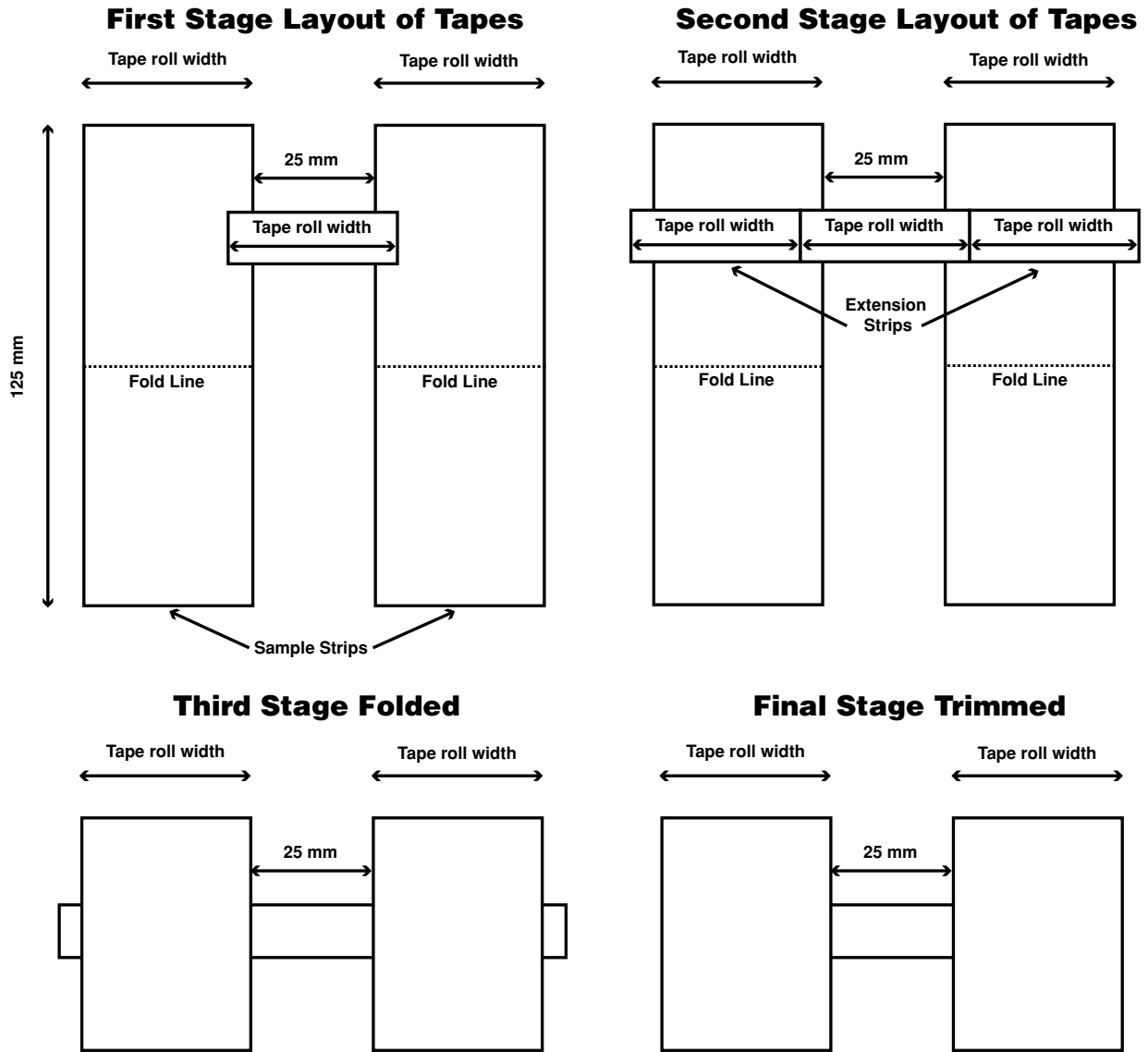

Figure 2. Sample layout for cross direction testing.



Call Letters	PSTC-133
Date of Issuance	09/55
Revised	04/66
Revised	08/85
Revised	08/89
Revised	10/03
Revised	05/07

## Thickness (Caliper) of Pressure Sensitive Tapes

### 1. SCOPE

1.1 This specification covers the determination of the thickness (caliper, gauge) of pressure sensitive tapes at standard conditions.

Afera: Association des Fabricants Europeens de Rubans Auto-Adhesives (Association of European Tape Manufacturers)

ASTM: American Society for Testing and Materials (USA)

EN: European Norm (Europe)

PSTC: Pressure Sensitive Tape Council (North America)

### 2. REFERENCED DOCUMENTS

2.1 ASTM Standards

D3652/D3652M Standard Test Method for Thickness of Pressure-Sensitive and Gummed Tapes

D3715/D3715M Practice for Quality Assurance of Pressure-Sensitive Tapes

E 122 Practice for Choice of Sample Size to Estimate a Measure of Quality for a Lot or Process

2.2. Afera

Afera 5006 Test Method for Thickness of Pressure Sensitive Tape

### 3. DEFINITION

3.1 Thickness is the perpendicular distance between the opposite surfaces of a tape usually expressed in millimeters.

### 4. SIGNIFICANCE

4.1 The thickness is of value in controlling uniformity and providing design data, as well as being used to determine physical and electrical properties. The test is useful for quality control and for acceptance testing for conformance to specification.

### 5. EQUIPMENT

5.1 Thickness gauge capable of estimating the thickness to within 0.002 mm. See Figure 1.

5.2 The gauge shall have two plane faces, the smaller of which is circular and has a diameter of 5 to 16 mm. The faces shall be parallel to within 0.005 mm and constrained to move apart in an axis perpendicular to themselves.

5.3 When the specimen is placed between the faces, it shall be under a steady pressure of 40 to 60 kPa (5.8 to 8.7 lb./square in.).

### 6. SAMPLING

6.1 Acceptance sampling shall be done in accordance with ASTM Practice D3715/D3715M.

A Summary of Changes section appears at the end of this test method.

6.2 Sampling for other purposes - The sampling and the number of test specimens depends on the purpose of the testing. Practice E 122 (see section 2) is recommended. It is common to test at least five specimens of a particular tape. Test specimens should be taken from several rolls of tape and, whenever possible, among several production runs of tape. Strong conclusions cannot be based on test results of a single unit (roll) of product.

## **7. TEST SPECIMEN**

7.1 The test specimen width shall be greater than the diameter of the foot of the micrometer and at least 50 mm long. It shall be free of wrinkles and creases.

7.2 Unwind and discard at least three but not more than six outer wraps of tape from the sample roll before taking specimens for testing.

7.3 Unless otherwise specified, remove one specimen per sample roll for each test performed. Remove the specimen from a freely rotating roll at the rate of approximately 500 to 700 mm/s. Where width or other factors make it impossible to remove the specimen at the prescribed rate, remove it at a rate as close to 500 mm/s as possible.

## **8. CONDITIONING**

8.1 Unless otherwise specified, condition the rolls in the conditions described in Appendix A for no less than 24 hours.

## **9. PROCEDURE**

9.1 Place the specimen between the jaws of the micrometer, adhesive side up and lower the presser foot gently upon the surface of the tape at least, whenever possible, 6 mm from the edge of the tape. Record the reading of the dial to the nearest 0.002 mm one second after lowering the foot. Make three readings for each specimen. Average the readings for the thickness value of that specimen.

9.2 To measure double-coated tapes with liner, measure the thickness of the specimen with one liner in place as in 9.1. Mark the liner where readings are made. Remove the liner and repeat the measurements as in 9.1 on the liner in the marked positions. Average both sets of readings, subtract the smaller average from the larger average, and record the differences as the thickness.

9.3 To measure double-coated tapes with liner, measure the thickness of the specimen with line in place as in 9.1. Mark the liner where readings were made. Remove the liner and repeat the measurements as in 9.1 on the liner in the marked positions. Average both sets of readings, subtract the liner average thickness from the total (tape plus liner) average thickness and record the difference as thickness.

## **10. REPORT**

10.1 The report shall include the following:

10.1.1 Statement that this method was used and indicate any deviations from the method as written.

10.1.2 Report the average of the readings made in section 9 as the thickness value in mm to the nearest 0.002 mm.

10.1.3 Complete identification of each roll tested including tape source, manufacturer's code number, and form.

10.1.4 Report the diameter and pressure used (see sections 5.2 and 5.3).

## 11. KEYWORDS

11.1 Thickness, caliper, gauge, pressure sensitive tape.

---

## SUMMARY OF CHANGES

- Updated section 2
- Revised the ranges for foot diameter and foot pressure in section 5.2 and 5.3
- Added section 10.1.4

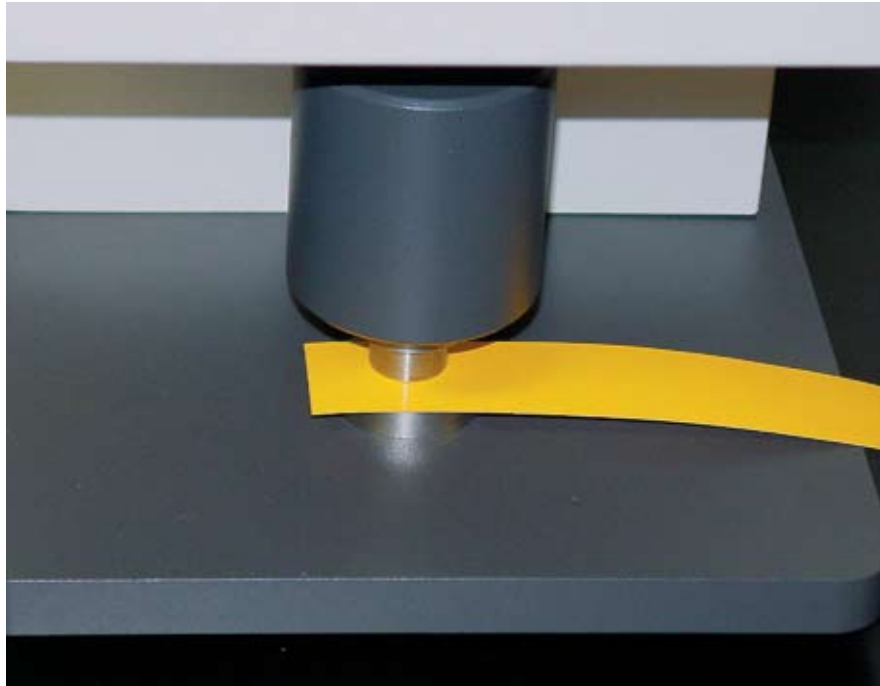

Figure 1. Tape sample being tested for thickness in micrometer.

Call Letters	PSTC-34
Date of Issuance	09/55
Revised	04/66
Revised	11/70
Revised	08/85
Revised	08/89
Revised	06/00
Revised	10/03
Revised	05/07

## Water Vapor Transmission of Pressure Sensitive Tapes

### 1. DEFINITION

1.1 Water vapor transmission is the weight of water vapor allowed through a controlled area of a tape within a specified period and under controlled conditions.

### 2. SIGNIFICANCE

2.1 Water vapor transmission is an important property to be determined when tape is to be used to seal against humidity.

### 3. TEST SPECIMEN

3.1 Three test specimens at least 48 mm (2") wide and 150 mm (6") long shall be prepared from each sample roll.

### 4. EQUIPMENT - See Appendix B

4.1 A humidity cabinet that shall provide a relative humidity of 90% to 95% at a temperature of  $38^{\circ}\text{C} \pm 0.5^{\circ}\text{C}$  ( $100^{\circ} \pm 1^{\circ}\text{F}$ ) with no condensation on the test dishes or in the space in which the test dishes are placed. The circulation over the test dishes shall be negligible. Equipment known as the general foods cabinet, or equivalent, is satisfactory for this test.

4.2 Water vapor cup. Figure 1.

4.3 Eight mesh anhydrous calcium chloride.

4.4 Analytical balance.

### 5. TEST METHOD

5.1 Fill the cup to within 3 mm ( $1/8''$ ) of the opening with eight mesh anhydrous calcium chloride and assure that it will not make contact with the adhesive of the test specimen. Apply the tape specimen, adhesive face down, over the opening to allow a minimum of 12 mm ( $1/2''$ ) of tape to be in contact with the sides of the flange and 24 mm (1") to be in contact with the ends. The tape adhesive shall be brought into intimate contact with the flange using ample finger pressure. The tape shall be trimmed to the flange dimensions. If air bubbles are apparent in the applied tape, a new specimen should be prepared. See Figure 2.

5.1.1 When the adhesive is lacking or has insufficient bonding strength to the flange to maintain a seal during the exposure period, and when the parties concerned are interested exclusively in the barrier properties for pathways normal to the surface of the tape backing, a pressure sensitive material such as aluminum foil-backed pressure sensitive tape can provide assurance that only the 24 mm x 100 mm (1.0" by 4.0") area at the flange opening is exposed and all edges covered.

5.2 Place the assembly in the humidity cabinet for 24 h conditioning period. Remove from the cabinet, cool for 15 min. at standard conditions, and weight on an analytical balance to the nearest third decimal place. This weight is W1 in paragraph 6.1.

5.2.1 For materials with a WVTR of 2.5 g/100 sq inches/24 h or less, after the initial weighing, return the assembly to the humidity cabinet for 72 h, remove, condition at standard conditions for 15 min., and weigh. Use this weight as W2 in paragraph 6.1.

A Summary of Changes section appears at the end of this test method.

5.2.2 For materials with a WVTR of > 2.5 g/100 sq inches/24 h, after the initial weighing, return this assembly to the humidity cabinet for 48 h. Remove, condition for 15 min., and weigh. Use this weight as W2 in paragraph 6.1.

## 6. REPORT

6.1 Calculate the water vapor transmission rate (WVTR) for each specimen in g/100 sq inches of tape area in 24 h to the nearest 0.05 g as follows:

Water Vapor Transmission Rate (WVTR) equals:

$$\frac{(W2 - W1) \times 2400}{T \times A}$$

where:

- W1 = weight (in grams) before exposure period
- W2 = weight (in grams) after exposure period
- T = exposure time (in hours)
- A = area (in square inches) of opening in dish (4).

6.2 Report the average of the transmission rates for the three specimens.

Another method for determining water vapor penetration rate of pressure sensitive tape is ASTM D 3833.

---

## SUMMARY OF CHANGES

- Made consistent metric references of 24 mm and 48 mm for standard 1" and 2" tape rolls.



Figure 1. Water vapor cup side view.

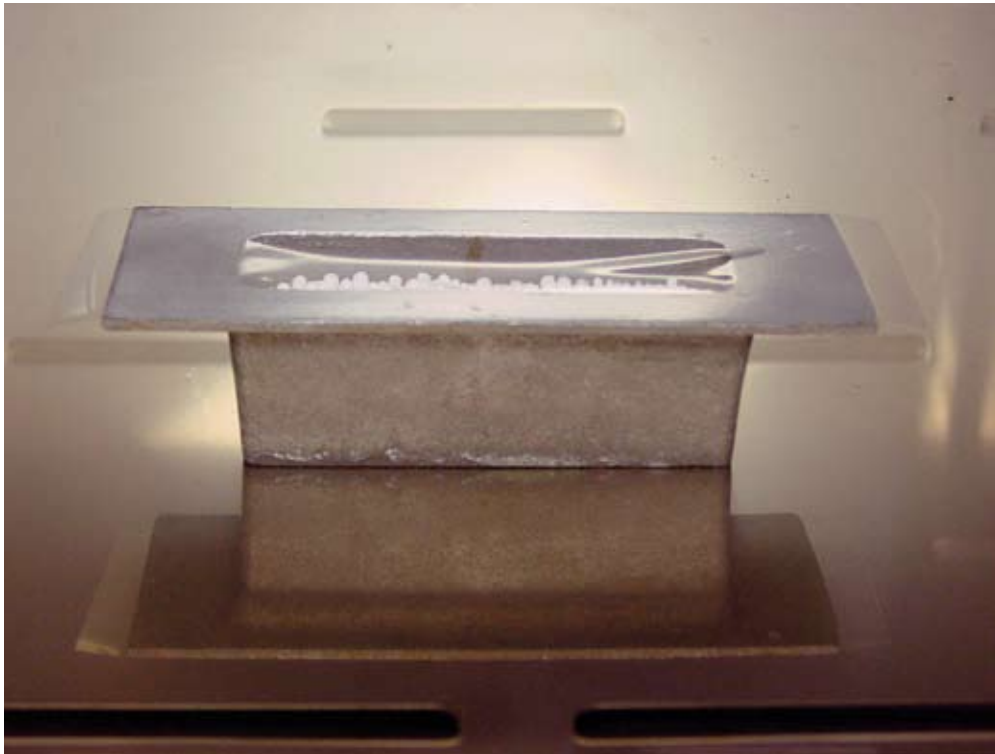

Figure 2. Water vapor transmission rate testing.

Call Letters	PSTC-35
Date of Issuance	09/55
Revised	04/66
Revised	11/70
Revised	08/85
Revised	08/89
Revised	06/00
Revised	10/03
Revised	05/07

## Water Penetration Rate of Pressure Sensitive Tapes

### 1. DEFINITION

1.1 Water penetration rate is the weight of the water transmitted through a controlled area of a tape, within a specified time period and under controlled conditions.

### 2. SIGNIFICANCE

2.1 Water penetration is an important property to determine when the tape may be exposed to water, if it is to be used for sealing purposes.

### 3. TEST SPECIMEN

3.1 Three test specimens at least 48 mm (2") wide and 150 mm (6") long shall be prepared from each sample roll.

### 4. EQUIPMENT - See Appendix B

4.1 Water vapor cup.

4.2 A container of sufficient depth to cover test specimen with a 24 mm (one-inch) head of water.

4.3 Eight mesh anhydrous calcium chloride.

4.4 Analytical balance.

4.5 Air-circulating oven.

4.6 De-ionized water

### 5. TEST METHOD

5.1 Fill the cup to within 3 mm (1/8") of the opening with eight mesh anhydrous calcium chloride and ensure that it will not make contact with the adhesive of the test specimen. See Figure 1. Apply the tape specimen, adhesive face down, over the opening to allow a minimum of 12 mm (1/2") of tape to be in contact with the sides of the flange and 24 mm (1") to be in contact with the ends. The tape adhesive shall be brought into intimate contact with the flange using ample finger pressure. The tape shall be trimmed to the flange dimensions. If air bubbles are apparent in the applied tape, a new specimen should be prepared.

5.1.1 When the adhesive is lacking or has insufficient bonding strength to the flange to maintain a seal during exposure period, and when the parties concerned are interested exclusively in the barrier properties for pathways normal to the surface of the tape backing, a pressure sensitive material such as aluminum foil-backed pressure sensitive tape can provide assurance that only the 24 mm x 100 mm (1.0" by 4.0") area at the flange opening is exposed and all edges covered.

5.2 Heat assembly in an air-circulating oven for 30 min. at 49°C (120°F) and cool for 30 min. at standard conditions. See Appendix A. Weigh on an analytical balance to third decimal place. This value is  $W_1$  in paragraph 6.1.

5.3 Submerge the assembly under about one inch of de-ionized water at standard conditions for 48 hours. See Figure 2 and 3.

A Summary of Changes section appears at the end of this test method.

5.4 Remove assembly from water and remove visible water from dish using a lint-free absorbent paper.

5.5 Place the assembly in an air-circulating oven at 49°C (120°F) for 120 min. Allow to cool for 30 min. at standard conditions and weigh. This value is  $W_2$  in equation 6.1.

## 6. REPORT

6.1 Calculate the water-penetration rate (WPR) for each specimen in g/100 sq in. of tape area per 24 h as follows:

$$WPR = \frac{(W_2 - W_1) \times 2400}{T \times A}$$

where:

$W_1$  = weight (in grams) before exposure period

$W_2$  = weight (in grams) after exposure period

T = exposure time (in hours) (48).

A = areas of exposed surface (in square inches) (4).

6.2 Report the average of the penetration rates for the three specimens.

Another method for measuring water penetration rate of pressure sensitive tape is ASTM D 3816.

---

## SUMMARY OF CHANGES

- Made consistent metric references of 24 mm and 48 mm for standard 1" and 2" tape rolls.





Figure 1. Water vapor cup filled with calcium chloride.



Figure 2. Water vapor cup placed in container.

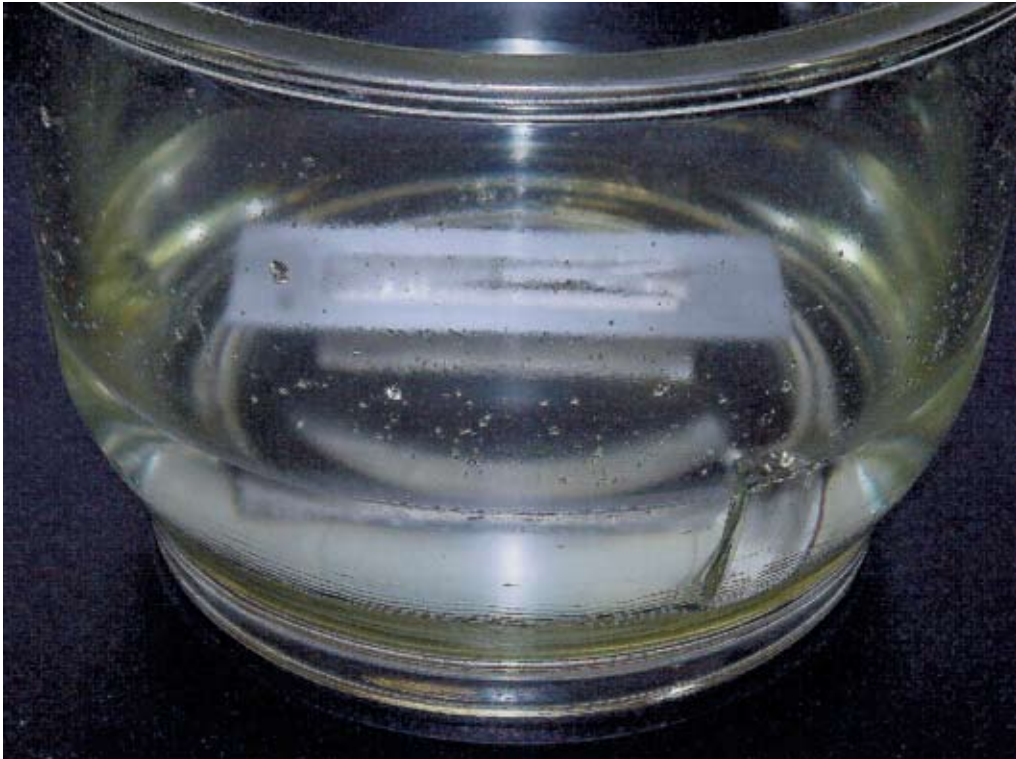

Figure 3. Container with water and test in progress.

Call Letters	PSTC-38
Date of Issuance	06/66
Revised	03/89
Revised	08/89
Revised	06/00
Revised	10/03

## Tear Resistance of Pressure Sensitive Tapes

### 1. DEFINITION

1.1 Tear resistance is the force required to propagate a tear in a tape in a given direction after the tear has been initiated.

### 2. SIGNIFICANCE

2.1 Tearing resistance is an important characteristic of tape in a number of applications.

### 3. TEST SPECIMEN

3.1 For test specimen conditioning, selection, and test conditions see Appendices A and D.

3.2 Specimens for the test shall be cut accurately in each principal direction of the tape about 75 mm (3") long by 63 mm (2 1/2") wide. Not less than five tests shall be made in each of the directions specified.

### 4. EQUIPMENT

4.1 Elmendorf tear test tester. See Figure 1.

### 5. TEST METHOD

5.1 A specimen shall be placed securely in the clamps. By use of the knife blade, a slit shall be cut in the specimen starting at the bottom edge and perpendicular thereto, and ending 43 mm (1.7") short of the top edge. The accuracy of the readings obtained with the apparatus depends to a great extent on the exactness of this 43 mm (1.7") of uncut specimen. The sector release shall be pressed, causing the sector to fall, thus moving the pendulum jaw away from the fixture so as to tear the specimen. The force required to tear the specimen in the given direction shall be read from the scale. Readings obtained where the tear deviates more than 10 mm (3/8") away from the line of the initial slit shall be rejected. Likewise, if the side of the specimen above the movable jaw rubs against the sector as the tear is made, the reading shall be rejected.

5.2 The test shall be made on enough layers of tape so that when torn together, the scale readings are between 20 and 60, and the number of layers shall be recorded.

5.3 When more than one layer is used, the layers of tape shall be placed adhesive to backing with the exposed adhesive of the outer layer being dusted with talc to completely nullify the tack.

5.4 Not less than five tests shall be made in each of the directions specified.

### 6. REPORT

6.1 Report the results as the average force in Newtons required to tear a single sheet. Since the scale readings are made 1/16 of the actual values, this is calculated by multiplying the average instrument readings by 16 and dividing by the number of layers torn at one time. Report the results obtained on strips torn in the machine direction as tearing resistance, machine direction, and on strips from across the machine direction as tearing resistance cross direction.

---

### SUMMARY OF CHANGES

No changes from the 14th edition.



Figure 1. Elmendorf tear test tester.

Call Letters	PSTC-39
Date of Issuance	06/66
Revised	11/70
Revised	08/85
Revised	08/89
Revised	06/00
Revised	10/03
Revised	05/07

## Tear Resistance of Plastic Film Tapes

### 1. DEFINITION

1.1 Tear resistance as determined by this method is a measure of the force necessary to initiate tearing in plastic film tapes ranging in thickness from 0.02 to 2 mm. This is contrasted with other methods which measure the force necessary to propagate a tear after it has been initiated.

### 2. SIGNIFICANCE

2.1 Tear resistance in plastic film tapes indicates how well-integrated the material will remain when it is used to conform to irregular shapes under tensions which vary across the width of the applied strip.

### 3. TEST SPECIMEN

3.1 For test specimen conditioning, selection, and test conditions, see Appendices A and D.

3.2 Prepare specimens using the die in Figure 1. When determining the cross direction tear, the 102 mm (4") dimension shall be in the machine direction. For measuring machine direction tear, the 102 mm (4") dimension shall be in the cross direction.

### 4. EQUIPMENT - See Appendix B

4.1 Die. See Figure 1. Same as Die "C" of ASTM D 624.

4.2 Tensile tester. See Figure 2.

### 5. TEST METHOD

5.1 Set the jaw spacing at 51 mm (2").

5.2 Clamp the specimen in the jaws, (see Figure 2) taking care that the jaws grip the specimen with the longitudinal axis of the specimen in line with the applied load. Operate the crosshead at a rate of 300 mm/min and assure that a chart record is made.

5.3 Read the maximum load recorded on the chart. This is the tearing resistance of the specimen.

5.4 Repeat sections 5.1 through 5.3 four more times for a total of five replicate tests.

### 6. REPORT

6.1 Report the median value of the tearing resistance as described in 5.3 and 5.4 to the nearest 0.1 N.

6.2 Report if the conditioning of sample and test conditions are different from Appendices A and D.

---

## SUMMARY OF CHANGES

- Changed the 50 mm jaw separation to 51 mm to more accurately represent the intended 2" jaw separation.
- Added section 5.4 to define recommended number of replicate tests.
- Revised section 6.1 to report the median value of the replicated measurements.



Figure 1. Die for sample preparation.



Figure 2. Tensile tester.

Call Letters	PSTC-50
Date of Issuance	06/66
Revised	08/85
Revised	08/89
Revised	06/00
Revised	10/03

## Shear Strength After Solvent Immersion of Electrical Grade Tapes

### 1. DEFINITION

1.1 Shear strength after solvent immersion is the force required to separate by shear a cured bond of given dimensions after immersion in a typical varnish solvent under designated conditions. It is a measure of the resistance of a cured tape adhesive to the action of a specific solvent.

### 2. SIGNIFICANCE

2.1 This is one method of quantifying the bond with pressure sensitive tapes when exposed to organic solvents. It is limited in that adhesion to itself or backing only are considered, while in-use tapes are generally adhered to various surfaces. Also, the solvent action is at room temperature, while often hot solvent action occurs in application. This method is not applicable to elastoplastic backings.

### 3. TEST SPECIMENS

3.1 Condition the roll per Appendices A and D. The sample shall be placed so that the conditioning atmosphere shall have free access to all normally exposed surfaces of the sample roll.

3.2 Discard at least three but no more than six outer wraps of the tape from the sample roll.

3.3 Six 24 mm (1") long specimens shall be removed from the roll so that the adhesive surface contacts neither the fingers nor any foreign object. Each specimen shall consist of two strips fastened together to form a 12 mm (1/2") long adhesive-to-adhesive or adhesive-to-backing lap joint. A 2,040 g  $\pm$  45 g (4 1/2 lb.) rubber-covered steel roller (see Appendix B) without application of additional pressure, shall then be passed over the joint once in each direction at the rate of 10  $\pm$  0.5 mm/s. The specimen shall be cut to 12 mm (1/2") width with a sharp razor blade.

### 4. EQUIPMENT - See Appendix B

4.1 A 2,040  $\pm$  45 g (4 1/2 lb.) rubber-covered steel roller.

4.2 Oven, forced air capable of maintaining 130°C  $\pm$  2°C (266°F  $\pm$  3.6°F).

4.3 Xylenes, lab or reagent grade.

4.4 Blotting paper.

4.5 Tensile tester with appropriate load cell for range being tested.

4.6 A 150 gram  $\pm$  1.5 gram weight.

### 5. TEST METHOD

5.1 Shear strength adhesive-to-adhesive - Cure three adhesive-to-adhesive specimens in an air-circulating oven maintained at 130°C  $\pm$  2°C (266°F  $\pm$  3.6°F) for 2 hours with a 150 gram load placed on the splice or other alternate conditions if agreed upon by the manufacturer and the customer. After cooling, immerse the specimens for 16 hours at room temperature in water-free xylene 23°C  $\pm$  2°C (73.4°F  $\pm$  3.6°F). Heptane or other specified solvent may be used by agreement. Place the specimens on clean blotting paper for 30 minutes, turn sample over after 15 minutes. Determine the breaking strength of the bond. Clamp specimen tightly in jaws of tensile tester. Make certain that edges of the sample are parallel with the jaws of the tensile tester. Pull apart at a speed of 300 mm (12"/minute) until the bond separates.

A Summary of Changes section appears at the end of this test method.

5.2 Shear strength adhesive-to-backing: same as 5.1 except use adhesive-to-backing sample.

## 6. REPORT

6.1 Complete identification of the tape.

6.2 Identification of the solvent used.

6.3 Identification of alternate conditions if agreed upon between manufacturer and customer.

6.4 Kind of test, adhesive-to-adhesive or adhesive-to-backing.

6.5 Average shear strength of bond obtained expressed in pounds-force per inch, plus the maximum, if specified. Note breakage of tape if such occurs.

6.6 Differences in test results of < 2.3 kg (5 lbs.) per inch width have no significance.

6.7 A minimum of three samples from three random rolls is acceptable.

Another method for measuring shear strength after solvent immersion of electrical grade tape is ASTM D 1000.

---

## SUMMARY OF CHANGES

No changes from the 14th edition.



Figure 1. Sample in tensile tester.



Call Letters	PSTC-51
Date of Issuance	09/59
Revised	08/85
Revised	08/89
Revised	06/00
Revised	10/03

# Dielectric Breakdown of Electrical Grade Tapes

## 1. DEFINITION

1.1 Dielectric breakdown is a measure of the maximum voltage stress which a single layer of tape can withstand before dielectric failure occurs, the test being carried out under prescribed conditions.

## 2. SIGNIFICANCE

2.1 The dielectric breakdown of a tape is an indication of its ability to withstand electrical stress. This value does not correspond to the dielectric strength expected in service, but is a numerical value which may be used for purchase by specification, as an indication of quality, and for comparison of different tapes or different lots of the same tape, and, to a limited degree, for design work when coupled with experience. The comparison of dielectric breakdown of different tapes after widely differing moisture conditions gives an indication of the quality of the compound used in the tape backing as a moisture-resistant dielectric.

## 3. TEST SPECIMENS

3.1 Condition the roll for at least 24 hours prior to testing in an atmosphere maintained at  $23^{\circ}\text{C} \pm 2^{\circ}\text{C}$  ( $73.4^{\circ}\text{F} \pm 3.6^{\circ}\text{F}$ ) and a relative humidity (RH) of  $50\% \pm 2\%$  at that temperature. The sample shall be placed so that the conditioning atmosphere shall have free access to all normally exposed surfaces of the sample roll.

3.2 Tapes that have backings that are not sensitive to water and/or water vapor such as vinyl, polyimide, polyethylene terephthalate, fluorocarbon polymer films, etc. shall be tested:

3.2.1 After 24 hours immersion in distilled or deionized water at  $23^{\circ}\text{C} \pm 2^{\circ}\text{C}$  ( $73.4^{\circ}\text{F} \pm 3.6^{\circ}\text{F}$ ). Note: Specimens shall be removed one at a time and dried by placing between layers of cotton toweling and pressing down gently over the entire surface. The sample shall then be tested immediately to prevent misleading results due to drying of the sample.

3.2.2 After 96 hours at  $23^{\circ}\text{C} \pm 2^{\circ}\text{C}$  ( $73.4^{\circ}\text{F} \pm 3.6^{\circ}\text{F}$ ) and 96% RH. Note: Practical methods of maintaining 96% relative humidity in small enclosures are described in the Recommended Practice for Maintaining Constant Relative Humidity by Means of Aqueous Solutions (ASTM E 104). Samples shall be removed from humidity chamber one at a time and tested immediately.

3.3 Discard at least three but no more than six outer wraps of the tape from the sample roll.

3.4 One 125 mm (5") long specimen shall be removed from the roll so that the adhesive surface contacts neither the fingers nor any foreign object. Each specimen shall consist of a single layer.

## 4. EQUIPMENT - See Appendix B

4.1 Testing device described in ASTM Method D 295. See Figure 1.

4.2 Desiccator with perforated plate.

4.3 Ammonium sulfate solution (super saturated) or equivalent for maintaining 96% RH at  $23^{\circ}\text{C} \pm 2^{\circ}\text{C}$  ( $73.4^{\circ}\text{F} \pm 3.6^{\circ}\text{F}$ ) in the desiccator.

4.4 Cotton toweling.

A Summary of Changes section appears at the end of this test method.

## 5. TEST METHOD

5.1 It is necessary to use a device whereby the specimen is held in place under pressure between two rubber washers while voltage is applied, to prevent flashover around the edges of the specimen being tested. Such a device is described in detail in the appendix to ASTM Method D 295. The electrodes (See Figure 2) that are part of the test fixture shall be opposing cylindrical rods 6.4 mm in diameter with edges square and ends rounded to 0.8 mm radius held together with a total load of  $50 \pm 2$  gm (include the weight of electrode), applied to the upper electrode (Type 3 ASTM D 140).

5.2 Using the appropriate test equipment, and with a suitable width sample (sufficient to prevent flashover) held between the two electrodes (see Figure 3), determine the dielectric breakdown by raising the voltage uniformly at 500 volts per second until strikethrough occurs.

5.3 Reject any test where results from arcing around the surface of the tape, when a wider sample width tape may be indicated. A minimum of 5 samples from randomly selected rolls is acceptable for reporting the average result.

## 6. REPORT

6.1 Complete identification of the tape including width and nominal or measured thickness.

6.2 Conditioning method used.

6.3 Average breakdown voltage, plus the maximum and minimum, if specified.

---

## SUMMARY OF CHANGES

No changes from the 14th edition.



Figure 1. Dielectric tester.



Figure 2. Dielectric electrode.

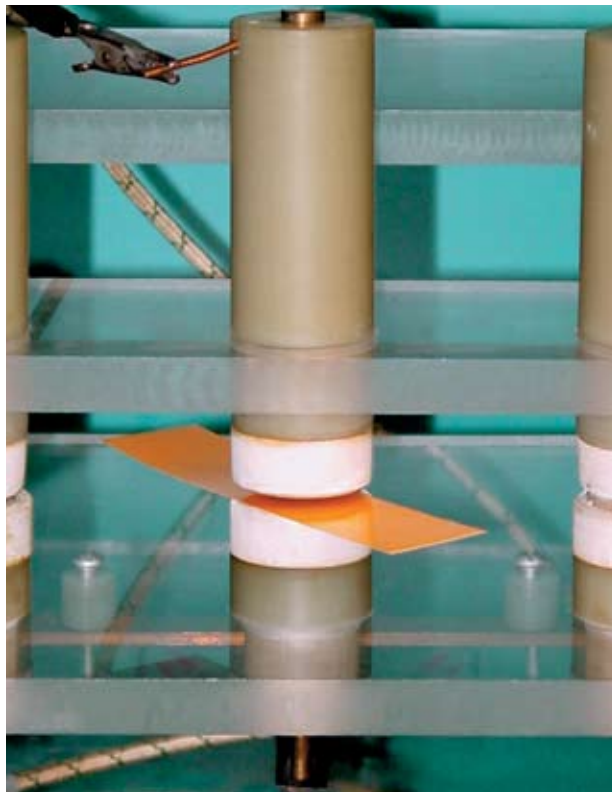

Figure 3. Dielectric sample.

Call Letters	PSTC-53
Date of Issuance	06/66
Revised	11/70
Revised	08/85
Revised	08/89
Revised	06/00
Revised	10/03

# Thermosetting Properties of Electrical Grade Tapes

## 1. DEFINITION

1.1 Thermosetting pressure sensitive tapes are produced with adhesive systems that cure or harden after exposure to heat, and remain set regardless of subsequent temperature cycles. The curing reaction involved is not reversible by heat, and tapes once heat-cured, remain cured. Thermosetting properties are measured by a bond separation test and are reported as the time to failure of a heat cured adhesive-to-adhesive bond under a prescribed load at a specified temperature.

## 2. SIGNIFICANCE

2.1 This test offers a means of differentiating between thermosetting and nonthermosetting tapes as application of stress on the bond after cure will result in bond failures within a few minutes for non-thermosetting adhesives, while bonds of true thermosetting adhesive tapes will hold for a controlled time before failure.

2.2 The length of time to failure of an adhesive-to-adhesive bond is also a measure of holding strength of the cured tape at an elevated temperature.

2.3 The test method is suitable for specification acceptance and service evaluation.

## 3. TEST SPECIMENS

3.1 Condition the roll for at least 24 hours prior to testing in an atmosphere maintained at  $23^{\circ}\text{C} \pm 2^{\circ}\text{C}$  ( $73.4^{\circ}\text{F} \pm 3.6^{\circ}\text{F}$ ) and a relative humidity (RH) of  $50\% \pm 5\%$  at that temperature. The sample shall be placed so that the conditioning atmosphere shall have free access to all normally exposed surfaces of the sample roll.

3.2 Discard at least three but no more than six outer wraps of the tape from the sample roll.

3.3 Six 150 mm (6") long strips shall be removed from the roll in accordance with Appendix D so that the adhesive surface contacts neither the fingers nor any foreign object.

3.4 Each test sample shall consist of two strips fastened together to form a 24 mm (1") long adhesive-to-adhesive lap joint.

3.5 A  $2,040 \text{ g} \pm 45 \text{ g}$  ( $4 \frac{1}{2} \text{ lb.}$ ) rubber-covered steel roller (see Appendix B), without application of additional pressure, shall then be passed over the joint once in each direction (lengthwise) at the speed of  $10 \pm 0.5 \text{ mm/s}$  (12" per minute).

3.6 The specimen shall be cut to 12 mm ( $\frac{1}{2}$ ") width with a sharp razor blade. If different width specimens with the same unit loading must be used, significant differences in test results may result.

## 4. EQUIPMENT - See Appendix B

4.1 A  $2,040 \pm 45 \text{ g}$  ( $4 \frac{1}{2} \text{ lb.}$ ) rubber-covered steel roller.

4.2 Oven, forced air capable of maintaining  $130^{\circ}\text{C} \pm 2^{\circ}\text{C}$  to  $200^{\circ}\text{C} \pm 2^{\circ}\text{C}$  ( $266^{\circ}\text{F}$  to  $392^{\circ}\text{F}$ ).

4.3 500 g  $\pm$  5 g test weights capable of being attached to the specimens.

4.4 Rack to hold strips in a vertical position.

A Summary of Changes section appears at the end of this test method.

## 5. TEST METHODS

5.1 Set an oven at the temperature specified in the following table according to the type of adhesive to be tested or at a temperature and time recommended by the manufacturer.

Tape Adhesive	Thermosetting Test Temperature	Thermosetting Time, hours
Natural or synthetic rubber	130°C (266°F)	2
Acrylic polymer	130°C (266°F)	2
Silicone polymer	200°C (392°F)	3

5.2 Place three assemblies of adhesive-to-adhesive samples on the shelf of an oven maintained at the thermosetting temperature for the time specified in the preceding table with no stress on the bond and a 150 gram load placed on the splice. Other alternate conditions may be used if agreed upon between the manufacturer and customer.

5.3 Remove the assemblies from the oven and allow them to cool for five minutes at room temperature.

5.4 Hang the specimens vertically in the oven at the test temperature with a 500-gram mass fastened to one end of each specimen (see Figure 1). Continue the test for a prescribed time, or until failure occurs by bond separation.

## 6. REPORT

6.1 Complete identification of the tape sample.

6.2 Report the average time of bond separation plus the maximum and minimum, if specified.

6.3 Report the average time of bond separation plus maximum and minimum if specified, together with the time/temperature cycle used to thermoset the adhesive. A minimum of 5 sets from randomly selected rolls is acceptable for reporting an average result.

---

## SUMMARY OF CHANGES

No changes from the 14th edition.

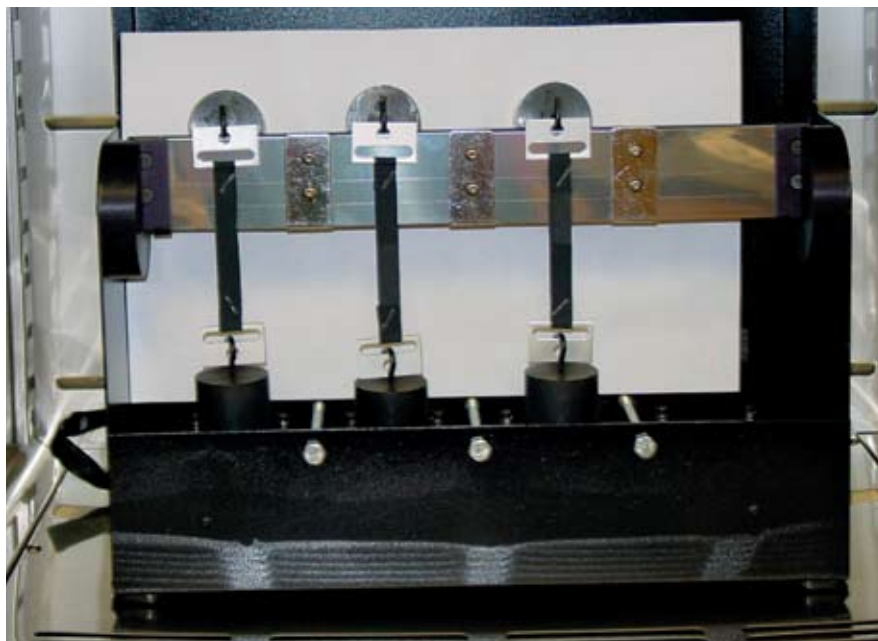

Figure 1. Tape samples mounted on test rack in oven.

Call Letters	PSTC-54
Date of Issuance	06/66
Revised	08/85
Revised	08/89
Revised	06/00
Revised	10/03

## Flagging of Electrical Grade Tapes

### 1. DEFINITION

1.1 Flagging is the lifting of an end of a tape that has been applied to a curved surface, thus forming a flag or tab tangent to the surface.

### 2. SIGNIFICANCE

2.1 This is one method of determining whether such properties as thickness, stiffness, and adhesion have been properly balanced for applications where flagging may occur.

2.2 Procedure A is for determining the flagging characteristic of tapes with non-elastic backings.

2.3 Procedure B is for determining the flagging characteristic of tapes with elastoplastic backings that have both high stretch and substantial recovery.

### 3. TEST SPECIMENS

3.1 Condition the roll for at least 24 hours prior to testing in an atmosphere maintained at  $23^{\circ}\text{C} \pm 2^{\circ}\text{C}$  ( $73.4^{\circ}\text{F} \pm 3.6^{\circ}\text{F}$ ) and a relative humidity (RH) of  $50\% \pm 5\%$  at that temperature. The sample shall be placed so that the conditioning atmosphere shall have free access to all normally exposed surfaces of the sample roll.

3.2 Discard at least three but no more than six outer wraps of the tape from the sample roll.

3.3 For Procedure A remove three strips of tape, about 125 mm (5") in length from each test roll and cut down to 12 mm (0.5") width. Specimens shall be removed from the roll so that the adhesive surface contacts neither the fingers nor any foreign object.

3.4 For Procedure B remove six strips of tape, about 200 mm (8") in length and cut down to 6 mm (0.25") width. Specimens shall be removed from the roll so that the adhesive surface contacts neither the fingers nor any foreign object.

### 4. EQUIPMENT - See Appendix B

4.1 Winding fixture, designed to hold a metal rod at each end and fitted with a crank or other device to rotate the rod so that the specimen may be wound thereon while tilting to an angle of approximately  $35^{\circ}$  to the horizontal. The fixture shall be attached to a rigid support with the rod held in a horizontal position.

4.2 Rods — Any suitable metal of 3 mm (0.125") or 6 mm (0.25") diameter and 125 mm (5") long. Rods of other diameters may be acceptable if agreed upon between the manufacturer and the customer. For Procedure B three clean brass rods of 3 mm (0.125") diameter are required.

4.3 Calibrated oven, forced air capable of maintaining  $130^{\circ}\text{C} \pm 2^{\circ}\text{C}$  ( $266^{\circ}\text{F} \pm 3.6^{\circ}\text{F}$ ).

4.4 Calibrated ruler, graduated in 1 mm (1/32") divisions.

4.5 Calibrated weight - Procedure A requires a mass of  $500 \pm 1$  g with a hook or other means for attaching to the specimen. Procedure B requires a  $50 \pm 1$  g for each 0.001" of nominal overall thickness of the tape, with a hook or other means for attaching to the specimen.

A Summary of Changes section appears at the end of this test method.

4.6 Razor blade.

4.7 A stand, typically a board, with 3 mm (0.125"), 6 mm (0.25"), or other diameter holes as agreed upon between the producer and user, spaced approximately 48 mm (2") apart on its surface to provide a base for supporting the wrapped rods in a vertical position.

## 5. TEST METHODS

### 5.1 Procedure A

5.1.1 Horizontally mount a rod of a required size in the winding fixture. For tapes of 0.025 mm (0.001") or less of backing thickness, use a 3 mm (0.125") diameter rod. For tapes having backing thickness greater than this, use a 6 mm (0.25") diameter rod.

5.1.2 Attach a 500 g weight to one end of a 125 mm (5") strip of tape. Holding the opposite end of the strip, drape the strip over the rod with the adhesive side contacting and adhering to the rod (see Figure 1). Rotate the rod so that the contact point is at the top of the rod and use a razor blade to trim the leading edge of the strip of tape flush with the rod.

5.1.3 Wind the tape on itself one complete turn, then a further 1/4 turn. Secure the rod from turning. Remove the weight and cut the tape by tearing against the razor blade edge held tangentially against the rod, taking care not to cut the lower layer of tape.

5.1.4 In the case of thermosetting tapes, cure the specimen assembly vertically in an oven for 2 h at  $130^{\circ}\text{C} \pm 2^{\circ}\text{C}$  ( $266^{\circ}\text{F} \pm 3.6^{\circ}\text{F}$ ) or for the time and the temperature agreed upon between the manufacturer and the customer. Remove the assembly from the oven and cool to room temperature. See Figure 2.

5.1.5 In the case of nonthermosetting tapes, insert wrapped specimens in holes in the base of the board with the flag at the upper end and allow them to condition at  $23^{\circ}\text{C} \pm 2^{\circ}\text{C}$  ( $73.4^{\circ}\text{F} \pm 3.6^{\circ}\text{F}$ ) and a relative humidity (RH) of  $50\% \pm 5\%$  for 24 hours.

5.1.6 In the case of tapes to be evaluated for resistance to solvents, cure the specimen assembly for 2 hours at  $130^{\circ}\text{C} \pm 2^{\circ}\text{C}$  ( $266^{\circ}\text{F} \pm 3.6^{\circ}\text{F}$ ) or at an alternate time and temperature agreed upon by the manufacturer and customer. Cool the specimens to room temperature and totally immerse them in a typical varnish solvent or cleaning solvent such as toluene for 15 min.

5.1.7 Measure the length of the unwound tape (flag) from the end of the tape to the point of tangent of the rod to the nearest millimeter ( $1/32$ "), as appropriate. If an uneven flag occurs, record the greatest length.

### 5.2 Procedure B

5.2.1 Secure a strip of tape by thread or light cord to the rod by making a few wraps while the rod is at a  $35^{\circ}$  angle. This portion may be removed after 5.2.2 is complete so that it is eliminated from the test. With the rod held in a horizontal position, attach the weight specified in 4.5 to the lower end of the tape. After 1 min. under tension, slowly rotate the rod and tilt the fixture approximately  $35^{\circ}$  degrees to the horizontal so that the strip of tape is wrapped for the length of the rod with successive turns closely butted without overlapping. It may be necessary to adjust the angle of the rod by successive trials until the proper angle for the particular tape is obtained. After wrapping is complete, secure the lower end of the tape and cut off any remaining length.

5.2.2 Then secure a second strip of tape over the first layer to the rod and apply it under tension with the weight specified in 4.5, except that the second layer shall be laterally displaced at 50% register with respect to the first layer. As the winding progresses to the lower end of the rod, insert a short length of lens tissue paper, 3 mm (0.125") wide under the tape across its width and parallel to the axis of the rod to serve as a starting point for the tape to unwind (flag). Remove the winding tension and cut the tape adjacent to the tissue strip that then serves as the benchmark for measurement of the unwind length.

5.2.3 Insert the wrapped specimens vertically into the holes in the base of the board with the flag at the upper end; allow them to condition at  $23^{\circ}\text{C} \pm 2^{\circ}\text{C}$  ( $73.4^{\circ}\text{F} \pm 3.6^{\circ}\text{F}$ ) and a relative humidity (RH) of  $50\% \pm 5\%$  standard conditions for 7 days. At the end of this period, measure the length of the flag from the point of tangency to the nearest edge of the tissue, to the nearest millimeter ( $1/32''$ ) as appropriate, taking care not to cause additional unwrapping in the measuring operation.

## 6. REPORT

6.1 Complete identification of the tape.

6.2 In Procedure A, rod diameter used.

6.3 In Procedure A, conditioning procedure used, including solvent type, if used.

6.4 Maximum, minimum, and average length of flag in inches or in millimeters, as appropriate.

Another method for measuring the flagging of electrical grade tapes is ASTM D 1000.

---

## SUMMARY OF CHANGES

No changes from the 14th edition.



Figure 1. Set-up for Procedure B.



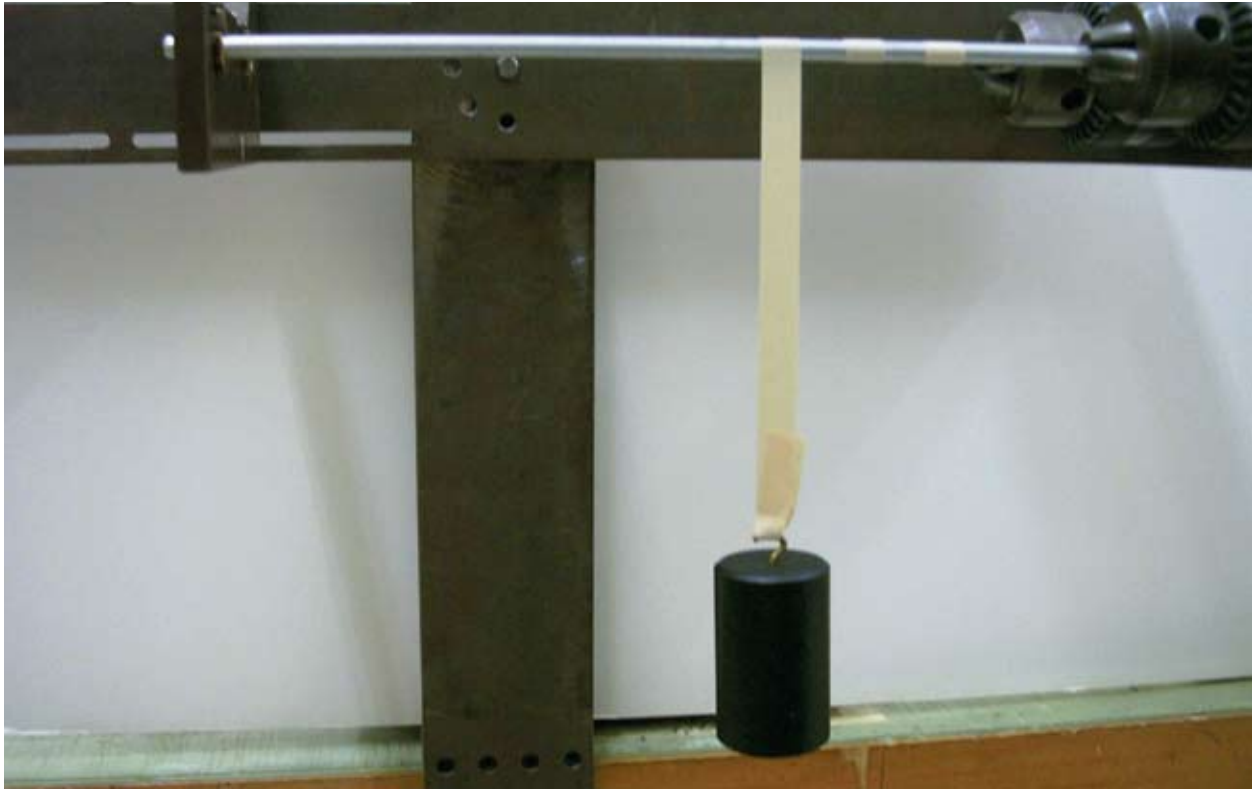

Figure 2. Flagging tape rod 500g weight.



Figure 3. Flagging rod in oven.

Call Letters	PSTC-55
Date of Issuance	06/66
Revised	08/85
Revised	08/89
Revised	06/00
Revised	10/03

## Oil Resistance of Electrical Grade Tapes

### 1. DEFINITION

1.1 The oil resistance of a pressure sensitive tape is the property of the adhesive to withstand the attack of the oil without impairment of its adhesion strength. This is measured by determining the adhesion strength after the tape is immersed in a specific oil for a given time at an elevated temperature.

### 2. SIGNIFICANCE

2.1 Pressure sensitive tapes may be used in locations where they contact oil or oil vapors that can affect the performance of the tape. An adhesion strength test after oil immersion is a method for determining this effect.

### 3. TEST SPECIMENS

3.1 Specimens shall be 250 mm (10") long and 6 mm (1/4") wide. Four specimens shall be removed from the roll so that the adhesive surface contacts neither the fingers nor any foreign object. Tape wider than 6 mm (1/4") shall be cut to that width with a sharp razor blade to prevent edge damage.

### 4. EQUIPMENT - See Appendix B

4.1 The test liquid shall be appropriate to the intended application of the tape and may be one or more of the following:

4.1.1 Mineral insulating oil meeting the requirements of ASTM Specification D 3487, Type I or Type II.

4.1.1.1 This oil is of a type common for immersion of transformers, switches, and circuit breakers.

4.1.2 Fire-resistant phosphate ester-based hydraulic liquid.

4.2 Test panels.

4.3 A 2 kg (4 1/2 lb.) rubber-covered steel roller.

4.4 Air-circulating oven.

4.5 A suitable container to fully submerge the test panels in the test liquid.

4.6 PSTC 101 adhesion testing equipment.

### 5. TEST METHOD

5.1 Adhesion to steel plate - Clean the steel plate (see Appendix C) and immediately after removing the tape from the roll, apply the adhesive side down to the polished surface of the steel. The tape shall be rolled twice - once in each direction with the 4 1/2 lb. roller, at a rate of 300 mm/min (12"/min).

5.2 Apply the specimen so that 125 mm (5") length shall extend beyond the end of the plate. Apply four 6 mm (1/4") wide tape specimens to the plate so that there is a 3 to 6 mm (1/8" to 1/4") space between them.

A Summary of Changes section appears at the end of this test method.

5.3 When thermosetting tapes are used, cure the assembly in a mechanical convection oven maintained at  $130^{\circ}\text{C} \pm 2^{\circ}\text{C}$  ( $266^{\circ}\text{F} \pm 3.6^{\circ}\text{F}$ ) for 2 hours; remove, and maintain at room conditions for a minimum of 16 hours before testing.

5.4 Immerse the plate completely in the test oil for 72 hours at  $50^{\circ}\text{C} \pm 2^{\circ}\text{C}$  ( $122^{\circ}\text{F} \pm 3.6^{\circ}\text{F}$ ) in a vertical position with the free ends of the specimens adhered to the back of the plate. After removal from the oil, place the assembled specimen side down on a clean blotting paper for 30 min.

5.5 Measure the adhesion of each specimen in accordance with PSTC-101.

## **6. ADHESION TO BACKING**

6.1 For effect of oil on adhesion to backing, apply 6 mm ( $1/4''$ ) or wider strips to the plate in accordance with section 5.1, except wrap both ends around the plate. Apply 6 mm ( $1/4''$ ) wide specimens to these strips, immerse in oil, remove, and measure adhesion to backing (PSTC-101).

## **7. REPORT**

7.1 Complete identification of the tape.

7.2 Identification of the oil.

7.3 Kind of test (adhesion to steel or to backing).

7.4 Average of the four specimens' adhesion in Newtons/10 mm (lbs. per inch) of width or other appropriate units, plus the maximum and minimum, if specified.

Another method for measuring the oil resistance of electrical grade tapes is ASTM D 1000.

---

## **SUMMARY OF CHANGES**

No changes from the 14th edition.

Call Letters	PSTC-56
Date of Issuance	05/66
Revised	08/85
Revised	08/89
Revised	06/00
Revised	10/03

# Resistance to Penetration at Elevated Temperatures of Electrical Grade Tapes

## 1. DEFINITION

1.1 Resistance to penetration is the ability of film backed tape to withstand high unit pressure, as determined by the temperature at which the penetrator punctures the tape under the conditions of loading and temperature rise specified in this method.

## 2. SIGNIFICANCE

2.1 Pressure sensitive electrical tapes often are used in contact with irregular contours. The high areas of these contours may press against other surfaces and produce small areas of high pressure which are potential sources of electrical failure at the operating temperature. This test gives a measure of resistance of film-backed tapes to penetration. Differences in penetration temperature of less than 3°C have no significance.

## 3. TEST SPECIMENS

3.1 Five specimens approximately 24 mm (1") long shall be prepared according to Appendix D at standard conditions according to Appendix A.

## 4. EQUIPMENT - See Appendix B

4.1 Penetration tester. A penetration tester as shown in Figure 1 is recommended.

The component parts of the penetration tester are: (See Figures 2 and 3.)

4.1.1 Load-bearing system, composed of a 1.6 mm (1/16") magnetized steel rod, recessed at one end to hold a 1.6 mm (1/16") diameter steel ball bearing against the test specimen mounted on a 102 mm x 30 mm x 3 mm (4 x 1.25 x 0.124") stainless steel plate.

4.1.2 Weight system, capable of exerting a force of 1000 g on the magnetized steel rod, including a counter-balance with a rider capable of being adjusted to neutralize the pressure of the ball bearing against the steel plate at no load.

4.1.3 Light C-clamp, containing the steel rod, counter-balance, and weight, mounted on a bearing capable of giving the unit the necessary freedom of rotation.

4.1.4 Electrical circuit, with a 110-V AC supply and containing a 110-V glow lamp.

4.2 An oven capable of holding the penetration tester and raising the temperature of the steel plate at a rate of 1.0°C (1.8°F) per 2 min.

4.3 A device for measuring the temperature of the steel plate immediately below the point of contact of the ball bearing. A thermocouple should be used for this application.

## 5. TEST METHOD

5.1 With no load on the rod, each specimen shall be inserted between the steel ball and the steel plate with the adhesive surface of the tape facing the plate. The tape shall be smooth against the plate and shall not be stretched.

5.2 Connect the electric circuit in such a way that when the steel ball comes in contact with the plate (when the specimen fails), the lamp outside the oven lights.

A Summary of Changes section appears at the end of this test method.

5.3 Apply the compression load of 1000 g to the specimen in the oven at room temperature. Uniformly raise the temperature of the steel plate at the rate of 1°C (1.8°F) per 2 min. until failure of specimen is indicated by current flowing through the circuit, thus lighting the glow lamp outside the oven.

## 6. REPORT

6.1 Average thickness of the specimen.

6.2 Temperature in degrees C or F at which each specimen failed.

6.3 Average temperature in degrees C or F of failure of the five specimens.

NOTE - To facilitate testing, the initial temperature may be taken at 40°C (104°F). For convenience, five penetration testers may be constructed to test simultaneously the required number of specimens.

Other methods for measuring the resistance to penetration at elevated temperature of electrical grade tapes include ASTM D 876 and ASTM D 1000.

---

## SUMMARY OF CHANGES

No changes from the 14th edition.

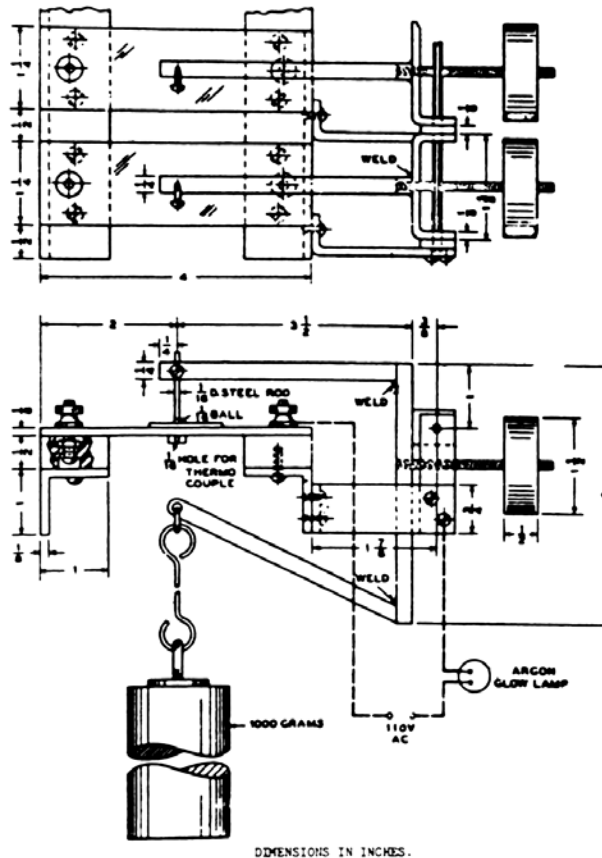

Figure 1. Penetration tester.

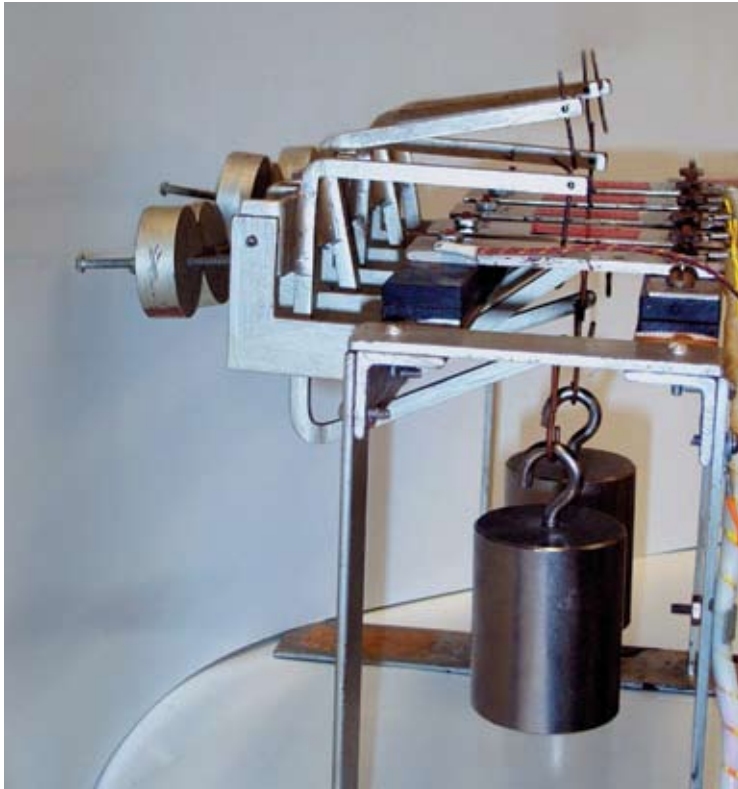

Figure 2. Penetration tester side view.

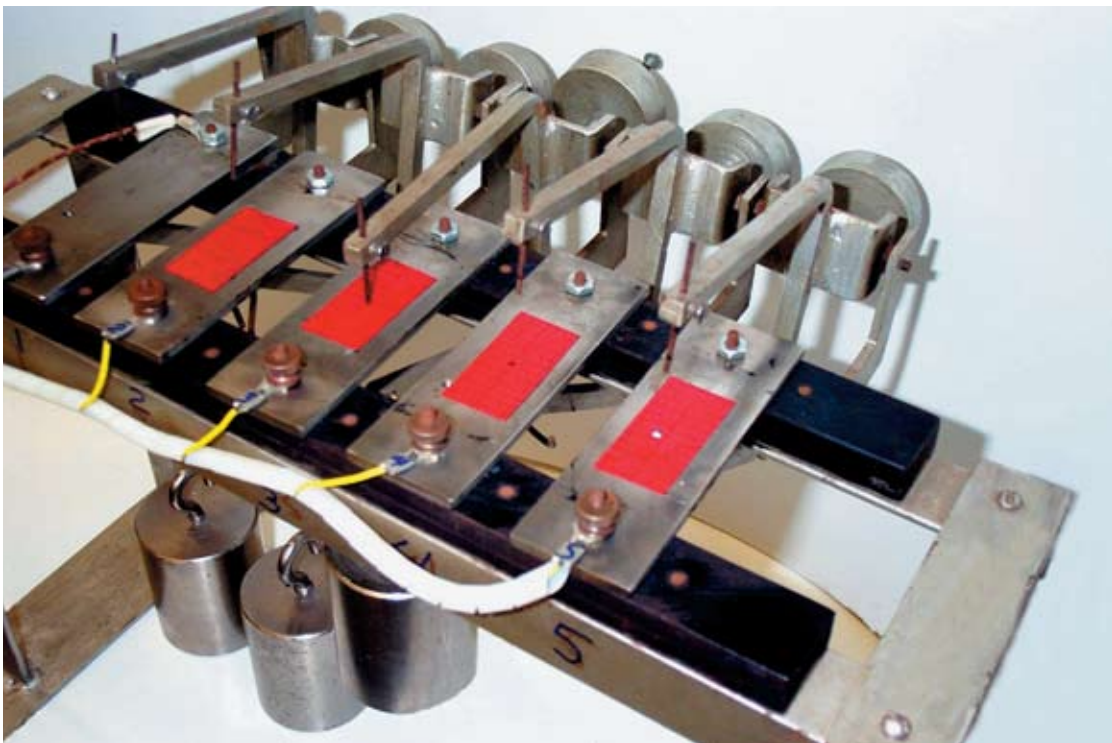

Figure 3. Penetration tester top view.

Call Letters	PSTC-57
Date of Issuance	06/66
Revised	08/85
Revised	08/89
Revised	06/00
Revised	10/03

## Flammability of Electrical Grade Tapes

### 1. DEFINITION

1.1 Flammability is the ability of a tape to self extinguish after exposure to a flame under controlled conditions.

### 2. SIGNIFICANCE

2.1 Flammability by this method differentiates between tapes having widely different burning characteristics but is less precise in differentiating between tapes within a narrow range of burning characteristics. The method should be used primarily for specification purposes inasmuch as the actual amount of tape used in any specific application and its configuration may alter the burning time.

### 3. TEST SPECIMENS

3.1 Condition the roll for at least 24 hours prior to testing in an atmosphere maintained at  $23^{\circ}\text{C} \pm 2^{\circ}\text{C}$  ( $73.4^{\circ}\text{F} \pm 3.6^{\circ}\text{F}$ ) and a relative humidity (RH) of  $50\% \pm 5\%$  at that temperature. The sample shall be placed so that the conditioning atmosphere shall have free access to all normally exposed surfaces of the sample roll.

3.2 Discard at least three but no more than six outer wraps of the tape from the sample roll.

3.3 Cut two strips of tape for each specimen 18 mm ( $3/4$ " ) wide by approximately 375 mm (15" ) long. In such a manner that fingers or any foreign object contacts the adhesive side.

### 4. EQUIPMENT - See Appendix B

4.1 Clean, straight brass rods, 3 mm ( $1/8$ " ) in diameter and 300 mm (12" ) long, free from any burned material. After use may require cleaning with a fine emery cloth and/or solvent.

4.2 Winding fixture: Designed to support a brass rod by the ends and a crank or other device to rotate the rod from either end so that the strips of tape may be wound onto the brass rods. The fixture shall be attached to a rigid support in such a manner that it may be rotated to the proper angle needed to achieve the correct lap in winding the tape.

4.3 Weights: As required to provide 150 g for each 0.025 mm (0.001" ) nominal overall thickness of tape and means for attaching them to the end of the tape to provide winding tension.

4.4 Bunsen burner: The gas flow cylinder shall be 9 mm ( $3/8$ " ) inside diameter.

4.5 Stop watch.

4.6 Level.

4.7 Stands and clamps: Arranged to support the test specimen horizontally.

4.8 Enclosure: To provide a draft-free enclosure such as a hood with exhaust fan off.

4.9 Gas supply: Public utility or propane gas may be used. For referee tests, commercial grade propane gas having a nominal heating value of 2521 Btu/ft<sup>3</sup> and a specific gravity of 0.508 at 15.5°C (60°F) shall be used at a line pressure of 270 mm (11" ) water column.

A Summary of Changes section appears at the end of this test method.

## **5. TEST METHOD**

5.1 Place one of the rods in the fixture while held in a horizontal position. Secure one end of a strip of tape near one end of the rod by making a couple of wraps while keeping the rod at a 35° angle. Attach a weight as required by 4.3 to the lower end of the tape. See Figure 1. After 1 min. under tension, slowly tilt the fixture and rotate the rod so that the tape wraps on the rod with a 1/2 lap for a length of 250 mm ± 9 mm (10" ± 3/8"). Remove the weight.

5.2 Reverse the rod on the fixture and repeat the procedure above so that a second strip of tape shall be wrapped over the first strip in the opposite direction. This completes the preparation of the test specimen.

5.3 Support the specimen in a horizontal position in the draft-free enclosure using the stands and clamps. Use the level to verify that the sample is horizontal.

5.4 Ignite the Bunsen burner and adjust the flame to produce a 75 mm (5") outer cone and 37 mm (1.5") inner cone.

5.5 Apply the Bunsen burner flame vertically to the specimen so that the tip of the inner cone touches the center of the specimen. Start the stop watch at the instant the flame is applied to the specimen. Allow the flame to remain in contact with the specimen for 30 seconds.

5.6 After 30 seconds, immediately turn off the gas. Do not remove from the burner or create a new draft. When the specimen ceases to burn, stop the stop watch. Subtract 30 seconds from the total time recorded and report the time in excess of 30 seconds as the flammability of the test specimen.

## **6. REPORT**

6.1 Complete identification of the tape.

6.2 Average burning time in seconds, plus the maximum and minimum, if specified.

6.3 Observations on the burning characteristics and condition of the burned specimens.

6.4 A minimum of three samples from three random rolls is acceptable.

Another method for measuring the flammability of electrical grade tapes is ASTM D 1000.

---

## **SUMMARY OF CHANGES**

No changes from the 14th edition.





Figure 1. Flammability sample preparation.

Call Letters	PSTC-58
Date of Issuance	05/07

## Insulation Resistance at High Humidity (Indirect Electrolytic Corrosion)

### 1. DEFINITION

1.1 The insulation resistance of an adhesive tape is the ratio of a direct voltage applied between two electrodes applied at a distance apart along the length of the tape, to the resulting current between them. This electrical resistance method is an indication of the possible corrosive effect of a PSA tape on metals under conditions of high humidity.

### 2. SIGNIFICANCE

2.1 Electrolytic corrosion can produce open circuit failures in electrical conductors and devices. The initiation and progression of electrolytic corrosion are influenced by temperature, humidity, time exposure, voltage level, whether the applied voltage or current is direct or alternating, and the characteristics of the metals involved. By measuring the insulation resistance of tape samples in contact with specified metal electrodes at high humidity, the presence and influence of electrolytic corrosion is detected (as a decrease in the insulation resistance or as an increase in the leakage current).

### 3. TEST SPECIMENS

3.1 Test specimens shall be single thickness' of tape each 24 mm (1") wide by approximately 150 mm (6 inches) long selected as described in Appendix D.

### 4. EQUIPMENT

4.1 Electrodes - Use 6 mm (1/4-in.) square stainless steel, brass or copper bars having the side in contact with the tape polished smooth and flat and the corners slightly rounded. Mount the electrodes in such a way that the tape under test is clamped between electrode pairs spaced 24 mm (1") from edge to edge. Use a guard so that only the current flowing in the tape is measured. The electrical resistance of the insulating material used between each set of electrodes should be sufficiently high so that only the current flowing in the tape is measured. One arrangement, suitable for testing a number of tapes at the same time, has several rows of electrodes mounted on the inside of the cover of the humidity chamber as shown in Figures 1 and 2. A satisfactory method of attaching guarded electrodes to the cover and bringing out a terminal for each electrode is shown in Figure 3.

4.2 Measuring equipment - A source of stable direct-voltage potential within the range from 100 to 130 V and a means of measuring current ranging from 0.001 to 1000  $\mu$ A. Stable direct-voltage power supplies are satisfactory voltage sources. Recommended meter is any quality, high resistance, solid state measuring instrument, with a suitable resistance range that will impress the required potential on the sample and over the required conductance range.

### 5. TEST METHOD

5.1 Preparation of electrodes - Clean the electrodes by dipping in acetone and then wiping with a clean, soft cloth saturated with heptane in a well-ventilated area. (Caution: Do not use in the vicinity of open flames or electrical contacts.) Polish the electrodes of brass or copper with No. 0 emery polishing paper, rinse in acetone, and then wipe with a heptane-saturated soft cloth.

A Summary of Changes section appears at the end of this test method.

5.1.1 Warning - Lethal voltages may be present during test methods which evaluate electrical properties. It is essential that the test apparatus, and all associated equipment that may be electrically connected to it, be properly designed and installed for safe operation. Solidly ground all electrically conductive parts that any person might come in contact with during the test. Provide means for use, at the completion of any test, to ground any parts which: were at high voltage during the test; may have acquired an induced charge during the test; may retain a charge even after disconnection of the voltage source. Thoroughly instruct all operators in the proper way to conduct tests safely. When making high voltage tests, particularly in compressed gas or in oil, the energy released at breakdown may be sufficient to result in fire, explosion, or rupture of the test chamber. Design test equipment, test chambers, and test specimens so as to minimize the possibility of such occurrences and to eliminate the possibility of personal injury.

5.2 Calibration of high resistance meter - Clamp a resistor (of a value within one decade of the anticipated specimen resistance) across the electrodes and measure the resistance with 100 to 130 V dc applied.

5.3 Specimen clamping - Without stretching the test specimen, place it between the bar electrodes evenly. Firmly clamp the tape between the electrodes taking great care to avoid contact between the hands and any tape surfaces between electrodes..

5.4 Conditioning - Condition the tape mounted in the electrodes inside the test chamber for  $18 \pm 0.1$  h at a relative humidity of  $96 \pm 2\%$  at  $23 \pm 1^\circ\text{C}$  ( $73.4 \pm 1.8^\circ\text{F}$ ).

A satisfactory method to obtain constant relative humidity of 96% at  $23^\circ\text{C}$  ( $73.4^\circ\text{F}$ ) is by an aqueous glycerin solution. Use a good industrial grade of glycerin ("high gravity" or "Dynamite" grades are satisfactory) in distilled water. The correct concentration will have a refractive index of 1.3560. It is recommended that 4 drops of a saturated solution of copper sulfate be added per 100 ml of solution to prevent fungus growth.

5.5 Measuring - At the end of the conditioning period, and while the tape is still in the humidity chamber, measure the resistance of the tape between each of five pairs of electrodes. Take readings 15 s after impressing 100 to 130 V dc between the electrodes. Calculate and record all values, and the median resistance of the five specimens.

## 6. REPORT

6.1 Report the following information:

6.1.1 All the values and the median, Megohm

6.1.2 Pass or fail depending on the requirements of the reference specification

6.1.3 The reciprocal of the insulation resistance in micro mhos is quoted as the indirect electrolytic corrosion

Another method for determining insulation resistance can be found in ASTM D 1000.

---

## SUMMARY OF CHANGES

This method is published for the first time in the 15th edition.

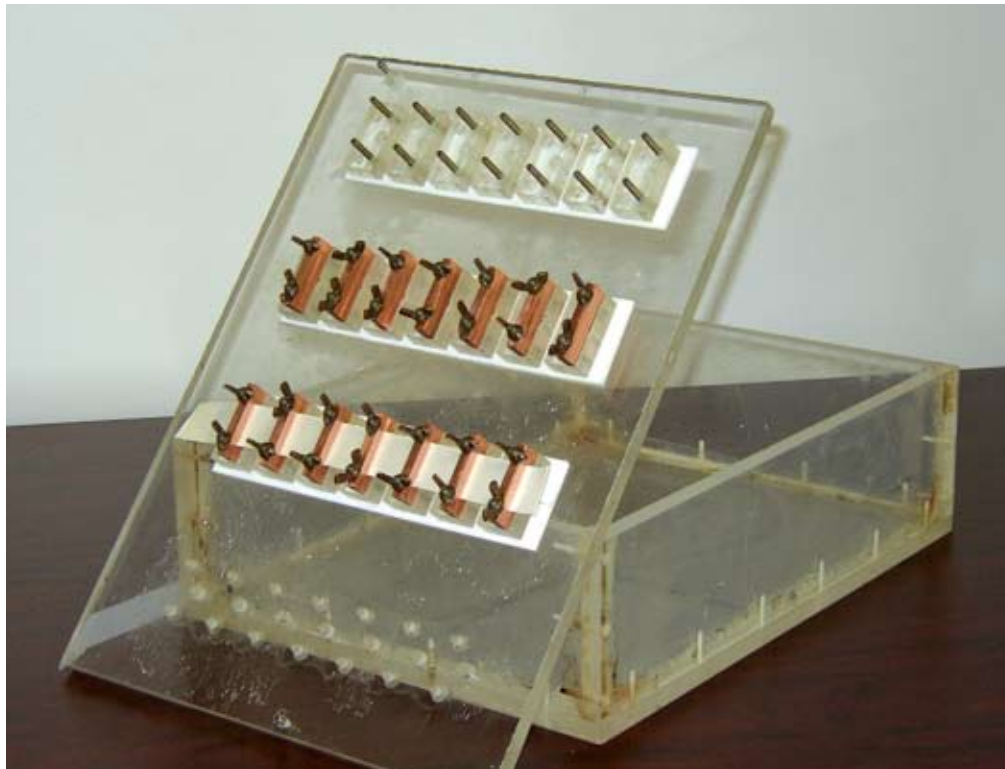

Figure 1. An arrangement for testing multiple tapes at the same time.



Figure 2. An arrangement for testing multiple tapes at the same time.

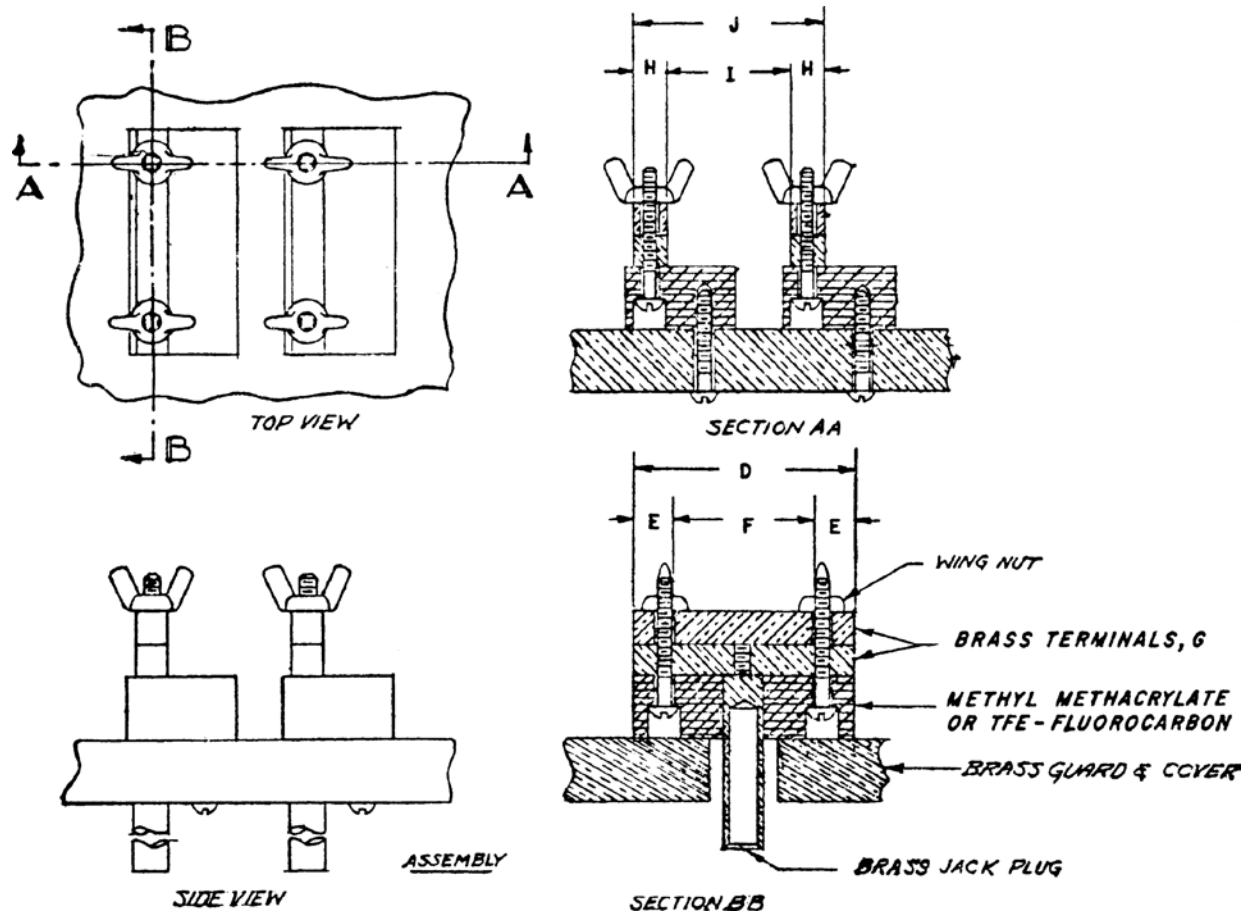

Figure 3. Method of attaching electrodes to cover for insulation resistance (indirect electrolytic corrosion) tests.

Reprinted with permission from *D1000-04 Standard Test Methods for Pressure-Sensitive Adhesive-Coated Tapes Used for Electrical and Electronic Applications*, copyright ASTM International, 100 Barr Harbor Drive, West Conshohocken, PA, 19428

Call Letters	PSTC-71
Date of Issuance	05/94
Revised	03/96
Revised	10/03
Revised	05/07

# Guide for Width and Length of Pressure Sensitive Tapes

## 1. DEFINITION

1.1 This document sets forth voluntary guidelines for widths and lengths of pressure sensitive tape, except tape used for medical, surgical, electrical and label stock purposes, including tolerances and labeling in the SI (metric) systems and inch-pound (English or Imperial) system.

1.2 Pressure sensitive tape is defined as a pressure sensitive adhesive coated substrate in roll form wound on a core, equal to or greater than 0.305 meter (12 inches) in length.

1.3 Roll length: The length of tape on a roll minus the tab and any tape on the core which cannot be removed and used for the intended purpose.

## 2. SIGNIFICANCE

2.1 Conformance to this guide will reduce chances of misunderstandings between suppliers and users of pressure sensitive tapes.

2.2 It is recommended that this guide be referenced where widths and lengths of pressure sensitive tapes are stated, such as in contracts, orders, advertisements and labeling.

## 3. UNITS OF MEASUREMENT

3.1 All widths and lengths are to be stated using a primary measurement system and a secondary measurement system, the latter being a calculated value using procedures described herein. The SI (metric) system is preferred as the primary measurement system.

3.2 The unit of width shall be millimeters (mm) or inches (in).

3.3 The unit of length shall be meters (m) or yards (yds). For rolls 72 yards (2592 in.) and under, the length may be stated in inches.

3.4 When width is stated in millimeters, the length shall be stated in meters. When width is stated in inches, the length shall be stated in yards or inches.

## 4. STANDARD WIDTHS

4.1 Preferred method: Metric system as primary.

4.1.1 When the metric system is used as the primary measurement system, widths are stated in a modular system with 3 mm increments for rolls under 24 mm, 6 mm increments for roll widths between 24 mm and 48 mm, and 12 mm for roll widths over 48 mm.

4.1.2 The inch width should be calculated and listed in addition to the primary metric with and the inch width should be stated in inches rounded down to the nearest one-hundredth of an inch.

4.2 Optional method: Inch-pound system as primary.

4.2.1 When the inch-pound system is used as the primary measurement system, roll widths are stated in a modular system with  $\frac{1}{8}$  in. increments for roll widths under 1 in.,  $\frac{1}{4}$  in. increments for roll widths between 1 and 2 in., and  $\frac{1}{2}$  in. increments for roll widths over 2 in.

A Summary of Changes section appears at the end of this test method.

4.2.2 The metric width should be calculated and listed in addition to the primary inch-pound width, and should be stated in mm rounded down to the nearest one-tenth of a mm.

## **5. TOLERANCES**

5.1 The applicable tolerance shall be that of the primary measurement system.

### 5.2 Width

5.2.1 In the SI (metric) system the width tolerance shall be  $\pm 0.8$  mm. This applies only to materials less than 1000 mm in width.

5.2.2 In the inch-pound system the width tolerance shall be  $\pm 1/32$  in. This applies only to materials less than 36 in. in width.

5.2.3 In any shipment or offering of tape, the average width of all rolls shall equal or exceed the stated value.

### 5.3 Length

5.3.1 For both the metric and inch-pound systems, the average roll length in any shipment or offering of tape shall equal or exceed the stated value. Roll length is defined as the length of tape on the roll minus the tab and any tape on the core which cannot be removed and used for the intended purpose.

## **6. LABELING**

6.1 With both systems the width will be stated first followed by the length.

6.2 The width and length as determined by the primary measurement system shall be listed first. The secondary, calculated, units shall be in parentheses.

## **7. CALCULATIONS OF SECONDARY MEASUREMENT**

7.1 When the primary measurement is the metric system, the inch-pound width is calculated using  $1 \text{ mm} = 0.03937 \text{ in.}$  The inch-pound width, rounded down to the nearest one hundredth of an inch, is stated as the secondary width. The inch-pound length is calculated using  $1 \text{ m} = 1.0936 \text{ yd.}$  The inch-pound length, rounded down to the nearest one-tenth of a yd., is stated as the secondary length (e.g.,  $48 \text{ mm} \times 50 \text{ m}$  [ $1.88 \text{ in.} \times 54.6 \text{ yd.}$ ]).

7.2 When the primary measurement is in the inch-pound system, the metric width is calculated using  $1 \text{ inch} = 25.4 \text{ mm.}$  The metric width, rounded down to the nearest one-tenth of a mm, is stated as the secondary width. The metric length is calculated using  $1 \text{ yd.} = 0.9144 \text{ m.}$  The metric length, rounded down to the nearest one-tenth of a meter, is stated as the secondary length (e.g.,  $2 \text{ in.} \times 60 \text{ yd.}$  [ $50.864 \text{ mm} \times 54.9 \text{ m}$ ]).

7.3 The secondary measurement is always rounded down to the nearest appropriate interval. In the example of paragraph 7.2,  $60 \text{ yd.}$  equals  $54.864 \text{ m}$  but the SI (metric) roll length in this case is stated as  $54.8 \text{ m.}$

## **8. TESTS**

8.1 Conditioning. Prior to dimensional measurements, the tape samples should be conditioned at  $23^\circ\text{C} \pm 2^\circ\text{C}$  ( $73.4^\circ\text{F} \pm 3.6^\circ\text{F}$ ) and  $50\% \pm 5\%$  relative humidity for 24 hours.

### 8.2 Width and length.

8.2.1 Apparatus. NIST\* traceable (calibrated) measuring device of sufficient accuracy.

8.2.2 Procedure. Any means which produces accurate and reproducible results on the tape without stretching or other deformation.

## **9. REFERENCE DOCUMENTS**

ASTM D 5750, Standard Guide to Width and Length of Pressure Sensitive Tape

## **10. COMMENTS**

This is a voluntary guide to be used except when the customer otherwise requires. Conformance does not ensure compliance with other standards, specifications, or legal requirements which may apply, nor does it imply endorsement of the product by the Pressure Sensitive Tape Council.

\*NIST: National Institute of Standards & Technology  
Washington, DC 20234

---

## **SUMMARY OF CHANGES**

- Removed reference to international harmonized standard
- Added section 1.3
- Clarified sections 6.2 and 7.3



Call Letters	Appendix A
Date of Issuance	06/66
Revised	11/70
Revised	08/85
Revised	08/89
Revised	10/03
Revised	05/07

## Standard Conditions

---

### 1. SCOPE

1.1 This method defines the term “standard conditions” used throughout this standard.

### 2. DEFINITION

2.1 Standard conditions are average conditioning temperature  $23^{\circ} \pm 1^{\circ}\text{C}$  ( $22^{\circ}\text{C}$  to  $24^{\circ}\text{C}$ ) and average relative humidity of  $50 \pm 2\%$  (48% to 52%) with total permitted variability of  $23^{\circ} \pm 2^{\circ}\text{C}$  ( $21^{\circ}\text{C}$  to  $25^{\circ}\text{C}$ ) for temperature and of  $50 \pm 5\%$  (45% to 55%) for relative humidity.

2.2 Unless otherwise specified in the test method, all tests shall be conducted in the conditioned chamber or room at standard conditions.

For further information on testing conditions refer to ASTM D 685 Standard Method for Conditioning Paper and Paper Products for Testing and ASTM D 1000 Standard Method - Pressure Sensitive Adhesive Coated Tapes used for electrical insulation.

---

### SUMMARY OF CHANGES

- Clarified definition in 2.1.

Call Letters	Appendix B
Date of Issuance	06/66
Revised	11/70
Revised	08/85
Revised	08/89
Revised	06/00
Revised	10/03
Revised	05/07

## Test Equipment

### 1. SCOPE

1.1 This appendix describes equipment used in methods found in this standard. It includes a description of equipment used in more than one method, and a table referencing each test method and the appropriate equipment required to conduct the tests described in these methods.

### 2. TEST EQUIPMENT DESCRIPTION

2.1 This paragraph describes equipment required by more than one test method in this standard.

#### 2.2 Adhesion testers

##### 2.2.1 Adhesion peel tester or slip/peel tester

The testing machine will be of the constant rate of extension type composed of a device for fixing the sample in a configuration that facilitates the testing of samples in the 90° as well as the 180° position, and a clamp that falls in a position where the center of each device is in the same plane. The tester sample holders also will be oriented so that they will be parallel to the direction of stress, and so aligned so that they will hold the specimen wholly in the same plane. A stress gauge or load cell and recording device will be part of the sample-holding apparatus and will be capable of recording the force required. A means of moving the stress jaw at a uniform rate of 300 mm/min (12"/min.).

##### 2.2.2 Adhesion/release tester

This equipment is the same as the above except the speed of the test can be adjusted to 300; 750; 1,500; 7,500; 15,000; and 30,000 mm/min (12, 30, 60, 300, 600 and 1,200"/min.) for the combination adhesion/release tester. The test bed stroke can be adjusted to as much as 400 mm (16").

##### 2.2.3 Tensile tester as described below in paragraph 2.3

#### 2.3 Tensile tester

2.3.1 The testing machine shall be of the constant rate of extension type composed of two clamps whose center shall be in the same plane, parallel with the direction of the motion of the stressing clamp, and so aligned that they will hold the specimen wholly in the same plane; a device for recording the tensile load and the amount of jaw separation; and a means of moving the stressing jaw at a uniform rate to be specified in the test method.

2.3.2 The tester should have a load range such that the test mean value falls between 20% and 80% of full scale.

2.3.3 In lieu of the clamping jaws, a pair of 102 mm (4") diameter cylinders shall be used when specified. These cylinders shall be constructed so that when they are attached to the tensile machine, the line of the tape during testing shall be parallel to the motion of the applied stress.

A Summary of Changes section appears at the end of this appendix.

## 2.4 Cutter, specimen.

2.4.1 The specimen cutter shall hold two single-edged razor blades in parallel planes, a precise distance apart, to form a cutter of exact specimen widths. Two cutters, 12 mm (0.5") and 24 mm (1") cutting width, shall be available.

2.4.2 The 12 mm (0.5") cutter shall consist of a 12 mm (0.5") thick by 200 mm (8") length of aluminum barstock 12 mm (0.5") wide. The edges for about 125 mm (5") from one end shall be rounded slightly to form a handle. The width of the bar for 75 mm (3") from the opposite end shall be narrowed to exactly 12 mm (0.5") minus the thickness of a single razor blade (one of two used as cutting edges). The razor blades shall be held in position using side plates. The end of the cutter shall be cut away at a 45° angle to expose the cutting edge at one end of the blades. The edges shall be separated by  $12 \pm 0.1$  mm ( $0.500 \pm 0.005$ ").

2.4.3 The 24 mm (1") cutter shall follow the same description as in 2.3.2, except that the barstock width shall be 24 mm (1") and shall be narrowed to exactly 24 mm (1") minus the thickness of a single razor blade.

## 2.5 Cup, water vapor transmission rate, and water penetration rate test.

2.5.1 The test cups shall be made from materials that are non-hygroscopic. The cup shall have a zero moisture vapor transmission rate (MVTR). The cups shall be rectangular with a flat, smooth, rigid flange, and shall have the following dimensions:

Flange: Outside  $50 \times 150 \pm 0.5$  mm ( $2.0 \times 6.0 \pm 0.02$ ").

Inside (opening):  $25 \times 102 \pm 0.5$  mm ( $1.0 \times 4.0 \pm 0.02$ ").

Body: Inside  $25 \times 102 \times 37.5$  (depth)  $\pm 0.5$  mm ( $1.0 \times 4.0 \times 1.5$  (depth)  $\pm 0.02$ ").

The mass shall not exceed 80% of the balance capacity used in weighing.

## 2.6 Panel

2.6.1 A  $50 \times 125 \times 1.2$  mm ( $2 \times 5 \times 0.048$ ")  $\pm 10\%$  panel of 304 stainless steel, free from burrs or sharp edges, having a bright annealed finish. The surface roughness shall be  $0.05 \pm 0.025$  microns ( $2 \pm 1$  micro inches) ( $R_a$ ). The deviation in flatness in both the machine and the cross direction of the bright annealed surface shall be 0.125 mm (0.005") maximum. The surface shall be free of contaminants such as process oils, and visual defects such as blemishes and scratches.

2.6.2 Panels with other shapes and dimensions may be formed or cut from the same steel and finish when specified by an individual method. The surface, directional flatness, and edges should still meet the requirements of 2.6.1. This paragraph will be cited with the necessary exceptions.

2.6.3 The bright annealed surface of any panels during storage or shipment should be covered with a residue free wrapper.

2.6.4 Panels showing or developing stains, discoloration, or scratches are not acceptable.

## 2.7 Roller, mechanically operated, rubber covered.

2.7.1 A steel roller,  $81 \pm 2.5$  mm ( $3.25 \pm 0.1$ ") in diameter and  $43.75 \pm 1.25$  mm ( $1.75 \pm 0.05$ ") in width, covered with rubber approximately 6.25 mm (0.25") in thickness and having a Shore scale A durometer hardness of  $80 \pm 5$ . The surface of the roller shall be a true cylinder void of any concave or convex deviations. The mass of the roller shall be  $2 \pm 0.05$  kg ( $4.5 \pm 0.1$  lb<sub>m</sub>).

2.7.1.1 A simple check to determine if the rubber surface is cylindrical is to wrap a very thin paper (onion skin) and roll it across a flat glass plate on which is placed carbon paper, face up. The carbon rubs off onto the thin paper to reveal high spots or hollows on the rubber surface.

2.7.1.2 For foil tapes only. A steel roller  $125 \pm 25$  mm ( $5.0 \pm 1$ "") in diameter with a total weight of  $4.5 \pm 0.05$  kg ( $10.0 \pm 0.10$  lb<sub>m</sub>) shall be used. The cylindrical surface of the roller shall be a true cylinder void of any concave or convex deviations so that the roller will apply a uniform pressure across the width of its entire surface.

2.7.2 A mechanically driven mount for the roller to move at either 300 or  $600 \pm 12$  mm/min. ( $12$  or  $24 \pm 0.5$ ""/min.) in one direction and return at the same speed in the opposite. The mount shall hold the roller so that, during rolling, the full weight of the roller (but only the weight of the roller) shall be allowed to act on the specimen. The roller shall be free turning on its own axis. The mount shall provide a means of lifting the roller so that, at rest the roller surface does not contact any object.

2.8 Roller, hand operated, rubber covered.

2.8.1 Roller as in 2.7.1

2.8.1.1 Roller as in 2.7.1.2

2.8.2 The roller construction shall not allow the weight of the handle to increase the weight of the roller during use.

2.9 Tear tester

2.9.1 The apparatus shall be an Elmendorf-type of tester conforming to the following:

2.9.2 A stationary clamp and a movable clamp carried on a pendulum preferably formed by a sector of a wheel or circle, free to swing on a balance or other substantially frictionless bearings;

2.9.3 A pointer and pointer stop to record the maximum arc of swing of the sector pendulum;

2.9.4 A sector release to hold the pendulum in the raised position during the mounting of the sample, and permitting it to follow through the force of gravity;

2.9.5 Pendulum carrying a circumferential graduated scale, so as to indicate the force used in tearing the specimen;

2.9.6 A knife attachment for initial slitting of the specimen.

2.9.7 With the pendulum in the raised position, the movable clamp shall lie in the same plane as the fixed clamp forming as it were an extension to the fixed clamp. This plane shall be perpendicular to the plane of oscillation of the pendulum. The gripping surface of the jaws in each clamp shall be 24 mm (1.0") by 16.5 mm (0.65"). The clamps shall be separated by a distance of 2.5 mm (0.1"). The knife attachment shall slit this specimen midway between the clamps at right angles to the upper edge of the clamps. The slit shall extend from the bottom edge of the specimen to a point of 4 mm (0.16") above the top edge of the clamps leaving a distance of 43 mm (1.72") of uncut specimen perpendicular to the long dimension of the specimen. The perpendicular from the line formed by the top edge of the clamps to the axis of suspension shall be 104 mm (4.2") and shall make an angle of  $27.5^\circ$  with the plane of the specimen.

### 3. EQUIPMENT

3.1 Possible sources of test equipment are:

ChemInstruments, 510 Commercial Drive, Fairfield, OH 45014; tel: 513-860-1598;  
www.chemsultants.com.

Paul N. Gardner Company, Inc., 316 North 1st First Street, Pompano Beach, FL 33060;  
tel: 954-946-9454; www.gardco.com.

Instron® Corporation, 825 University Ave., Norwood, MA 02062-2643; tel: 781-575-5000;  
www.instron.com.

IMASS Inc., PO Box 134, Accord, MA 02018; tel: 781-834-3063; www.imass.com.

MTS Systems Corporation, 14000 Technology Drive, Eden Prairie, MN 55344;  
tel: 800-328-2255; info@mts.com; www.mts.com.

Testing Machines, Inc., 2 Fleetwood Court, Ronkonkoma NY 11779; tel: 631-439-5400 or  
1-800-678-3221; info@testingmachines.com; www.testingmachines.com.

Texture Technologies Corporation, 18 Fairview Road, Scarsdale, NY 10583; tel: 914.472.0531;  
www.texturetechnologies.com.

Thwing-Albert Instrument Company, 14 Collings Ave., West Berlin, NJ 08091; tel: 856-767-1000;  
info@thwingalbert.com; www.thwingalbert.com.

Tinius Olsen, Inc., 1065 Easton Road, PO Box 1009, Horsham, PA 19044-8009; tel: 215-675-7100;  
info@tiniusolsen.com; www.tiniusolsen.com.

---

## **SUMMARY OF CHANGES**

- Corrected surface roughness measurement in section 2.6.1.
- Corrected mass of roller in 2.7.1.
- Corrected weight of steel roller in 2.7.1.2.
- Made consistent metric references of 24 mm and 48 mm for standard 1" and 2" tape rolls.
- Updated equipment supplier listings in section 3 and table 2.

**TABLE I - Method with Equipment Reference**

---

<b>Method</b>	<b>Equipment</b>
PSTC-101	Cutter, specimen Panel Roller, rubber covered, mechanically operated Adhesion tester / Tensile tester with 90° fixture
PSTC-5	Cutter, specimen Panel Quick stick test fixture Tensile tester
PSTC-6	Rolling ball tack tester Steel ball 11 mm (7/16") diameter
PSTC-107	Holding power test stand - room temperature version Holding power test stand - oven temperature version Holding power cut-off fixture Panel Roller, rubber covered, hand or mechanically operated Specimen tester
PSTC-8	Fixture with free-turning mandrel Tensile tester
PSTC-9	Vessel forced-convection oven, ammonium sulfate, distilled water
PSTC-11	Roller, rubber covered, hand operated Nonrotating metal cylinder Oven, circulating (65.5 °C [150 °F]), Cold Chamber (-18.3 °C [-1 °F])
PSTC-13	Variable speed unwind machine
PSTC-14	Panel Stop watch Cutter, specimen Punch, paper, single hole Holding power test stands, horizontal Roller, rubber-covered per Appendix B
PSTC-15	Coating apparatus (50 microns [2 mil] dry thickness capable) Vented drying chamber Circulating oven Tensile Tester with 90° fixture or release testing machine Panels Roller per Appendix B
PSTC-16	Cutter, specimen Panel Test fixture Tensile tester Loop tack tester
PSTC-21	Roller, rubber covered, hand operated Ultraviolet light source (RS lamp) 102 x 102 mm (4 x 4") test panels Paint spray equipment Convection oven
PSTC-22	Roller, rubber covered, hand operated 102 x 102 mm (4 x 4") test panels Paint spray equipment

PSTC-131	Cutter, specimen Tensile tester with pneumatic clamps or 102 mm (4") diameter cylinders
PSTC-133	Thickness gauge or micrometer as specified
PSTC-34	Cup, water vapor transmission rate Humidity chamber maintained at $37.8 \pm 2^{\circ}\text{C}$ ( $100 \pm 3.6^{\circ}\text{F}$ ) and 90% to 95% RH Balance, analytical
PSTC-35	Cup, water penetration rate Container for water at least 102 mm (4") deep Balance, analytical
PSTC-38	Elmendorf tear test tester
PSTC-39	Tensile tester, die
PSTC-50	Cutter, specimen Tensile tester
PSTC-51	Dielectric strength tester per ASTM D 149
PSTC-53	Holding power test stands Cutter, specimen Roller, rubber covered, hand operated Weight, 500 g (1.1 lbm)
PSTC-54	Tape winding fixture (see ASTM D 1000) Weight, 500 g (1.1 lbm) Air-circulating oven ( $130^{\circ}\text{C}$ )
PSTC-55	Panel Roller, rubber covered, hand operated
PSTC-56	Penetration tester per Figure 1, ASTM D 876 Oven with $1^{\circ}\text{C} / 2$ minute increase rate
PSTC-57	Brass rods Winding fixture Weights Bunsen burner Stop watch Stands and clamps Level Enclosure Gas supply
PSTC-71	Ruler (Metric or English)

Individual methods may require different test weights.  
Refer to Section 4 of the different methods.

**TABLE 2 - Equipment Sources**

TYPE	PSTC TEST NO.	DESCRIPTION	OTHER TEST METHODS				CHEM INSTRUMENTS EQUIPMENT	CHEM INSTRUMENTS ACCESSORIES	IMASS	INSTRON	THWING ALBERT	
			TLMI	ASTM	AFERA	FINAT						
Peel & Release	101(A-F) 4B	90 & 180 deg Peel/Release	L-IA1	D3330 (A - F)	5001 P-11	1, 2, 3, 5, 10, 11	AR-1000 or TT-1000 PA-90 PA-180	RD-3000 HR-100 TP-26 SC-012 / 024	SP-2000 SP-2100 TL-2200 SPEC-1	Yes	EJA Vantage	
			L-IA2	D5375 (A,B) D6252			SO-8 AR-1000 TT-1000	TP-26 HR-100				
			L-IA3				LC-100 SOS-8 AR-1000 or TT-1000	PF-90 HR-100 TP-26				
High-speed Release	55	Oil Resistance				4	HSR-1000	NA	ZPE-1100W			
Tack	16	Loop Tack	LT	D6195 (A)		9	LT-1000 or TT-1000	TP-13 TP-16 SC-100 LTF-100			EJA Vantage	
				D2979			PT-1000	NA			EJA Vantage	
				D3121	5015		TT-100 TT-1000	NA PF-90	Yes		EJA Vantage	
Shear	107 (A-F), 14	Shear at ambient temperature	7	D6463 (B) D3654 (A)	5012	8	RT-10 or RT-30	HR-100 TP-23 SC-012 SC-024 TW-500 & 1000		Yes		
						18						EJA Vantage
Heated Shear Aging	53 107 (G)	Shear at elevated temperatures	SHR	D6463 (A) D4498			HT-8 or HT-30 & SO-8				EJA Vantage	
							TT-1000 SO-8	HR-100			EJA Vantage	
Thickness	33	Thickness Measurement	T-411	D3652 D645 D374	5006		MI-1000	NA			ProGage	
Unwind	8, 13	High Speed Unwind Force		D1000	5008		HSU-1000	NA			EJA Vantage	
			8		5013		TT-1000	UWF-100	SPA2-09		EJA Vantage	



TYPE	PSTC TEST NO.	DESCRIPTION	OTHER TEST METHODS				CHEM INSTRUMENTS EQUIPMENT	CHEM INSTRUMENTS ACCESSORIES	IMASS	INSTRON	THWING ALBERT
			TLMI	ASTM	AFERA	FINAT					
Tensile	31, 39	Tensile Strength of Material	L-1A1	D828	5004	TT-1000	SC-100		Yes	EJA Vantage	
			II-E	D903							
Burst		Burst Strength of Perforated Material	Burst DC1			BP-1000	NA			Yes	
			Penetration							Yes	
Aging & Drying	9,11			5026		SOS-8	NA				
Water Vapor Transmission	34			5002		WV-100	NA			Vapometer Cups	
Stain Test	21,22					SO-8	HR-100				
Water Penetration	35					SO-8	NA			Yes	
Tear	38	Tear Resistance	T-4141 om-98						Yes	Pro Tear	
Dielectric Breakdown	51										
Flagging	54										
Penetration	56										
Flamability	57			5009							
COF		Coefficient of Friction	Yes	D1894-99 D4518-91		COF-1000		Yes		Friction/Peel	
Contact Angle			Yes	D724-99		CAM-Plus				PG-3	

**Equipment Supplier Web Sites**

<p>ChemInstruments: <a href="http://www.chemsultants.com">www.chemsultants.com</a>  Paul N. Gardner Company, Inc.: <a href="http://www.gardco.com">www.gardco.com</a>  Instron® Corporation: <a href="http://www.instron.com">www.instron.com</a>  IMASS Inc.: <a href="http://www.imass.com">www.imass.com</a>  MTS Systems Corporation: <a href="http://www.mts.com">www.mts.com</a></p>	<p>Testing Machines, Inc.: <a href="http://www.testingmachines.com">www.testingmachines.com</a>  Texture Technologies Corporation: <a href="http://www.texturetechnologies.com">www.texturetechnologies.com</a>  Thwing-Albert Instrument Company: <a href="http://www.thwingalbert.com">www.thwingalbert.com</a>  Tinius Olsen, Inc.: <a href="http://www.tiniusolsen.com">www.tiniusolsen.com</a></p>
--	---

Call Letters	Appendix C
Date of Issuance	06/66
Revised	11/70
Revised	08/85
Revised	08/89
Revised	06/00
Revised	10/03
Revised	05/07

## Cleaning Test Surfaces

### 1. SCOPE

1.1 This method defines a cleaning procedure for use whenever the test method requires a clean panel or surface.

### 2. MATERIALS

2.1 Absorbent cleaning material, either surgical gauze or tissue.

2.1.1 To be suitable, materials must be lint free during use, absorbent, contain no additives that are soluble in the solvents listed in section 2.2, and be made exclusively from virgin materials.

2.2 Solvents

2.2.1 Diacetone alcohol

2.2.2 Reagent grade of one of the following:

normal heptane (n-heptane)

methyl alcohol (95%)

methyl ethyl ketone (MEK)

methyl isobutyl ketone (MIBK)

acetone

2.2.3 Where toxicity and flammability requirements are paramount, a suitably blended mixture of n-heptane and fluorinated hydrocarbon such as a refrigerant may meet requirements.

### 3. PROCEDURE

3.1 Dispense one of the solvents listed in 2.2 onto the panel, wiping it to dryness with fresh absorbent cleaning material. Repeat for a total of four washes with this solvent. See Figure 1.

3.2 Discard cleaned panels showing stains, discoloration, or numerous scratches.

3.3 Avoid contacting panel surface with fingers.

3.4 During storage, panels should be protected from damage by covering with any non-stretching, non-contaminating material such as tissue, soft felt or heavy fabric.

## ADDENDUM

---

### Procedure for Cleaning New Test Panels

- 1 New panels have residual machining oils and possible surfactants remaining from the protective covering. All new panels should be cleaned by wiping in the machine direction with a strong solvent such as methyl ethyl ketone or acetone and then placed in an oven at 350°F (175°C) for about 1 hour. The initial wash will remove some of the impurities, and the baking will cause any additional materials to discolor on the surface. After the panels have cooled, clean them again with methyl ethyl ketone or acetone. At this point, a standard cleaning method can be followed such as PSTC Appendix C or ASTM D 3330. (*Solvents should be used in well-ventilated area or vent hood.*)
- 2 It is advisable to mark the “grip” end of each panel when using a tensile tester to do adhesion testing. One should avoid gathering data from a scratched or roughened surface.
- 3 Handle test panels by the edges whenever possible. This will help keep skin oils out of the testing area of the panels.
- 4 If you stack your panels when not using them, put a soft lint free tissue between the panels to avoid scratching the testing surface. Or, consider using a test panel holder for storing these panels – see Figure 2.

---

### SUMMARY OF CHANGES

- Added acetone to the list of solvents in 2.2.2.
- Clarified the procedure in section 3.1.
- Added the addendum for cleaning new test panels.



Figure 1. Panel cleaning procedure

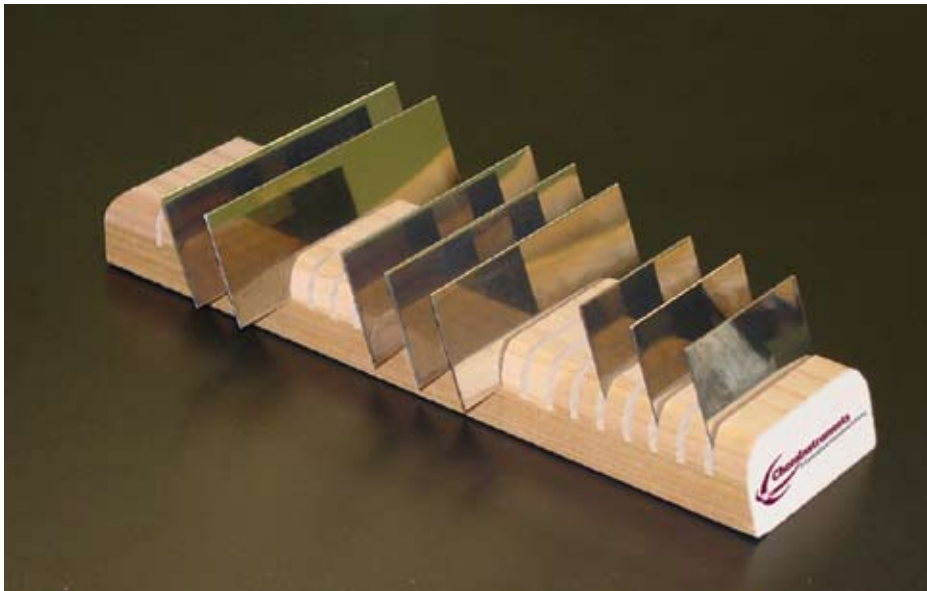

Figure 2. Test panel holder

Call Letters	Appendix D
Date of Issuance	06/66
Revised	11/70
Revised	08/85
Revised	08/89
Revised	10/03

## Preparation for Testing

### 1. SCOPE

1.1 This method defines the environmental conditions required for sample roll conditioning and indicates what steps are necessary towards specimen selection.

### 2. SAMPLE ROLL CONDITIONING

2.1 Unless otherwise specified, the sample roll(s) shall be conditioned for at least 24 hours prior to testing in an atmosphere maintained at standard conditions (Appendix A). The sample roll shall be placed in the chamber or room in such a way that the conditioning atmosphere shall have free access to all normally exposed surfaces of the sample roll.

### 3. SPECIMEN SELECTION

3.1 Discard at least three but no more than six outer wraps of tape from the sample roll before taking specimens for testing. This applies to rolls in the as-received and accelerated-aged condition.

3.2 Remove one specimen per sample roll for each test to be performed unless otherwise specified. Remove it from a freely rotating roll at the rate of 500-750 mm (20-30") per second. Where width or other factor causing a high adherence to backing makes it impossible to remove the specimen at the prescribed rate, remove it at a rate as close to 500 mm (20") per second as possible. Note: Care shall be taken when unrolling glass filament or glass fabric backed tapes so as not to fracture the glass. Preventing acute angles of unwinding will assist in doing this.

3.3 When the tape is wider than the dimension specified in the method, specimens of the widest specified width are to be cut from the center of a strip removed from the roll as in, 3.2.

3.3.1 A specimen cutter for use in preparing specified widths is defined in Appendix B.

---

### SUMMARY OF CHANGES

No changes from the 14th edition.

Call Letters	Appendix E
Date of Issuance	11/75
Revised	08/85
Revised	08/89
Revised	10/03

# Quality Assurance of Pressure Sensitive Tapes

---

## 1. SCOPE

1.1 The type of sampling plan used in the selection of samples for testing depends on the purpose of the tests to be performed on the samples.

1.2 If the purpose is to determine if a lot of product is acceptable under a prescribed standard, the sampling shall be in accordance with ASTM Practice D 3715.

1.3 If the purpose of the testing is to compare one product with another or where the number of available samples is small, ASTM Practice E 122 is recommended. It is common to test at least five specimens of a particular tape. Test specimens shall be taken from several rolls of tape and, whenever possible, among several production runs of tape. Strong conclusions about a specific property of a tape cannot be based on test results on a single unit (roll) of product.

---

## SUMMARY OF CHANGES

No changes from the 14th edition.

Call Letters	Appendix F
Date of Issuance	11/75
Revised	08/85
Revised	08/89
Revised	10/03

## Metric-English Conversion

CHARACTERISTICS/UNITS	CONVERSION FACTOR	SMALL CONVERSIONS
Width Thickness Millimeters Inches	mm = in. x 25.40 in. = mm x 0.0394	0.001" = 0.025 mm
Length Meters Yards	m = yd x 0.9144 yds = m x 1.094	100 yds = 91.44 m
Force Newtons lbs oz gm	N = oz x 0.2780 oz = N x 3.5969 N = lb x 4.4472 lbs = N x 0.2249 gm = 0.0353 oz	2 oz = 0.556 N 5 lbs = 22.2 N
Adhesion Quick Stick Unwind Newtons/100 mm oz/in.	N/100 mm = oz/in. x 1.0945 oz/in. = N/100 mm x 0.9136	10 oz/in. = 11 N/100 mm
Tensile Newtons/100 mm lb/in.	N/100 = lb/in. x 17.5127 lb/in. = N/100 mm x 5.72	5 lb/in. = 88 N/100 mm
Adhesion to Liner Newtons/100 mm	N/100 mm = g/in. x 0.03861	150 g/in. = 5.8 N/100 mm
Density kg/cubic meter lb/cubic feet	kg/m <sup>3</sup> = lb/ft x 16.0185 lb/ft <sup>3</sup> = kg/m x 0.0624	2 lb/ft <sup>3</sup> = 32 kg/m <sup>3</sup>
Pressure Kilopascals Megapascals psi	kPa = psi x 6.8948 psi = mPa x 145 mPa = psi x 0.006895 psi = mPa x 145	25 psi = 172.4 kPa 200 psi = 1.379 mPa
Permeability Grams/m <sup>2</sup> /24h Grams/100 in <sup>2</sup> /24 h	g/m <sup>2</sup> /24h = g/100in <sup>2</sup> /24h x 15.5 g/100 in <sup>2</sup> /24 h = g/m <sup>2</sup> /24 h x 0.0645	0.1 g/100 in <sup>2</sup> /24 h = 1.6 g/m <sup>2</sup> /24 h

A Summary of Changes section appears at the end of this appendix.

---

## **SUMMARY OF CHANGES**

No changes from the 14th edition.





# Glossary

From A to Z, all industry related terms and definitions are listed below.

## **ABRASION RESISTANCE**

The ability of a tape to withstand rubbing and still function satisfactorily.

## **ACCELERATED AGING**

A means whereby the deterioration of a tape encountered in natural aging may be accelerated and reproduced in the laboratory.

## **ACCELERATED WEATHERING** (weathering)

Exposure in a chamber to ultraviolet light, heat, and water whereby the effect of outdoor exposure on a tape can be approximated.

## **ADHESION TO BACKING**

The bond produced to the backing of the same tape or another tape backing.

## **ADHESIVE DEPOSIT OR RESIDUE**

Adhesive that is pulled away from the tape upon removal and remains on the surface to which it has been applied.

## **ADHESIVE TRANSFER**

The conveyance of adhesive from its normal position on the tape backing to a surface to which the tape was attached, either during unwind or removal.

## **ANCHORAGE**

The specific adhesion of a pressure sensitive adhesive to a face material or an anchor coat.

## **BACKING**

A relatively thin flexible material to which the adhesive is applied. Theoretically any material that is reasonably flat, thin, and flexible can be used as a tape backing.

## **BACKSIZE**

An occlusive coating applied to the non-pressure sensitive side of a porous backing such as paper in order to provide a satisfactory surface that the pressure sensitive adhesive side can contact when the tape is wound into a roll.

## **BLEEDING**

Penetration through the tape of a coloring material (paint, etc.) onto the surface to which the tape is applied.

## **BLOCKING**

Adhesion between the sheets of the plies of rolls of coated material, usually due to extreme conditions of pressure, temperature, or humidity.

## **BURSTING STRENGTH**

The ability of a tape to resist damage when a force is applied evenly and perpendicularly to the surface of a tape.

## **CALIPER**

The thickness (as of a sheet of paper) measured under specified conditions. See also THICKNESS.

## **CARRIER**

A webstock that holds a pressure sensitive adhesive, especially used to refer to double-faced or double-coated tapes.

## **COATING WEIGHT**

The weight of a coating per unit area. In SI-units expressed as grams per square meter (g/m<sup>2</sup>).

## **COHESION** (cohesive strength, internal bond)

The ability of the adhesive to resist shear stress and splitting. Good cohesion is necessary for clean removal.

## **COLD FLOW**

The tendency of a pressure sensitive adhesive to act as a heavy viscous liquid over long periods of time. Such phenomena as oozing and increase in adhesion with time are the result of this characteristic.

## **COLOR STABILITY**

The ability of a tape to retain its original color, particularly when exposed to light.

#### **CORONA RESISTANCE**

The ability of an elastomeric adhesive, coating, or sealer acting as an insulator to withstand the effects of high voltage discharge. Indications of failure appear as surface cracks.

#### **CREEP**

The slow movement of the adhesive or backing under shear stress.

#### **CROSS-LINKING**

Developing a three-dimensional molecular structure in an adhesive normally activated by heat or irradiation. An improvement in shear resistance, high temperature resistance, and oil or solvent resistance will normally result.

#### **CURE**

To alter the properties of an adhesive by chemical reaction, which may be condensation, polymerization, or vulcanization. Usually accomplished by the action of heat and catalysts, alone or in combination, with or without pressure.

#### **CURL**

The tendency of paper by itself or in a laminate to bend or partly wrap around the axis of one of its dimensions.

#### **DELAMINATION**

A separation or splitting of the tape such as separation of the backing into two distinct layers, separation between laminations of a tape consisting of more than one backing, separation between filaments and backing of a filament reinforced tape, or separation of the adhesive from the backing.

#### **DIELECTRIC STRENGTH**

The measure of the maximum voltage stress that a single layer of tape can withstand before dielectric failure occurs, the test being carried out under prescribed conditions.

#### **DIMENSIONAL STABILITY**

That property of a material that relates to the constancy of its dimensions, particularly in relation to external influences such as moisture or temperature.

#### **DOUBLE COATED**

An adhesive application to both sides of a backing.

#### **EDGE CURL**

The peeling back or lifting of the outer edge of an applied tape in a curved manner.

#### **EDGE LIFT**

The tendency for the edge of an adhesive label to lift from a surface to which it has been adhered.

#### **ELASTICITY**

The extensible property of adhesive films or adhesive interfaces to contract and expand in such a manner as to overcome the differential contraction and expansion rates that the bonded adherends may exhibit.

#### **ELASTOMER**

An elastic, polymeric substance, such as natural or synthetic rubber.

#### **ELECTROLYTIC CORROSION FACTOR**

A measure of the tape's corrosive effect on an electrical conductor, particularly copper. This is particularly important in the selection of tapes for electrical insulation.

#### **ELONGATION** (stretch, ultimate elongation)

The distance a tape will stretch in the machine or cross direction before breaking under controlled conditions, expressed as a percentage of original length. Elongation is not necessarily an indication of conformability.

#### **FACE STOCK**

Any paper, film, fabric, laminate, or foil material suitable for converting into pressure sensitive material stock. In the finished construction this web is bonded to the adhesive layer and becomes the functional part of the tape construction.

#### **FALL-OFF**

When a tape pulls completely from the surface to which it is applied and drops off.

#### **FATIGUE**

A weakness resulting from stress created by repeated flexing or impact force upon the adhesive-adherend interface.

#### **FILAMENTS**

Thin, longitudinal yarns or threads of glass, polyester, nylon, or other high strength materials.

#### **FLAKING**

A condition sometimes occurring during removal of masking tape in which flakes or particles of paint flake away from the tape backing.

**FLAME RESISTANCE**

The ability of a tape to withstand exposure to flame. Fireproof materials will not burn even when exposed to flame. Flame-resistant (fire-retardant, self-extinguishing) materials will burn when exposed to flame, but will not sustain the burn after the flame is removed.

**FLUTING**

Distortion of a roll of tape such that the layers no longer form a circle.

**GAPPING**

Openings between layers of tape within a finished roll.

**GLOSS**

A light reflection characteristic of tape backings, usually expressed by such terms as glossy, low gloss, matte, etc.

**HEAT SEAL**

An adhesive film intended to be reactivated by the application of physical or chemical changes caused by exposure to high temperatures.

**HIGH-SPEED UNWIND**

A term referring to the process of unwinding or dispensing of tapes at a relatively high rate of speed, usually over 15 meters / minute.

**HOLDING POWER** (shear adhesion, shear resistance)

The ability of a tape to resist static forces applied in the same plane as the backing. Usually expressed in a time required for a given weight and length of tape to shear free from a vertical panel.

**HOT MELT** (pressure sensitive adhesive)

A pressure sensitive adhesive, applied to the backing in hot liquid form, which then cools to form a conventional pressure sensitive adhesive.

**HUMIDITY**

The moisture content of the air. Actual humidity is the number of grams of moisture in the air at any given time. Relative humidity is the percent of moisture relative to the maximum that air at any given temperature can retain without precipitation.

**HYGROSCOPIC**

A tendency of some materials to readily absorb moisture from the atmosphere.

**IMPACT RESISTANCE** (shock resistance)

The ability of a tape to resist sudden impacts, pulls, or shocks as may sometimes be encountered by packages in transit.

**INSULATION RESISTANCE**

The ability of tape to prevent the flow of electrical current across its surface, usually measured on the backing.

**LABEL STOCK**

Pressure sensitive insulation. materials furnished in roll or sheet form with liner, which can be later printed, frequently die cut, and intended for use as labels.

**LAP JOINT**

A joint made by lapping one material over another to provide a mated area that can be joined with an adhesive.

**LATENT STAIN**

A stain in a surface to which tape has been applied, which does not become noticeable until some time after the tape is removed, usually after the surface has been exposed to sunlight or heat.

**LIFTING**

A situation where a section of tape has pulled away from the surface to which it has been applied.

**METAL FOIL**

Thin flexible sheets of metal, such as aluminum, copper, and lead, used as tape backings because of their inherent properties such as weather resistance, electrical conductivity, reflectivity, etc.

**MOISTURE VAPOR TRANSMISSION RATE**

A measure of the rate of water vapor transmission through a pressure sensitive product usually measured in grams / square meter / 24 hours.

**OFF-CORE**

A roll of tape in which the layers are in correct alignment, but the tape is displaced sideways on the core.

**OOZING**

A "squeezing out" of the adhesive from under the backing. Occurrence when a tape is in a roll form causes the edges of the roll to become tacky.

**OPACITY**

The ability of a tape to prevent the transmission of light.

**OUT-GASSING**

The release of volatile components under heat or vacuum.

#### **PATTERN COATED**

A term that refers to the width and spacing arrangement of strips of adhesive laid down parallel to machine direction and across the width of pressure sensitive stock during its production.

#### **PEEL ADHESION**

The force per unit width required to break the bond between a pressure sensitive adhesive tape and the surface to which it has been applied when the tape is peeled back at a controlled angle at a standard rate and condition.

#### **PLASTICIZATION**

The softening of an adhesive when exposed to migrating plasticizers or oils.

#### **PRESSURE SENSITIVE**

A term commonly used to designate a distinct category of adhesive tapes and adhesives which in dry form (solvent / water free) are aggressively and permanently tacky at room temperature and that firmly adhere to a variety of dissimilar surfaces upon mere contact without the need of more than finger or hand pressure. These products require no activation by water, solvent, or heat in order to exert a strong adhesive holding force toward such materials as paper, plastic, glass, wood, cement, and metal. They have sufficient cohesive holding power and elastic nature so that, despite their aggressive tackiness, they can be handled with the fingers and removed from smooth surfaces without leaving a residue.

#### **PRESSURE SENSITIVE ADHESIVE TAPE**

Pressure sensitive adhesive tape can be defined as a continuous flexible strip of cloth, paper, metal or plastic coated on one or both sides with a permanently tacky adhesive at room temperature which will adhere to a variety of surfaces with light pressure (finger pressure) with no phase change (liquid to solid) and usually in roll form.

#### **PRIMING**

Application of a thin layer of adhesive-like material to a backing that serves as a bonding agent between the backing and the final adhesive coat.

**QUICK STICK** (finger tack, initial adhesion, wet grab)

see **TACK**.

#### **RELEASE LINER**

A web of sheet material used as a protective liner, which covers the adhesive side of the tape. It is removed prior to application. Most frequently found on double- sided tapes and label stocks.

#### **RELEASE FORCE**

The measure of the force required to separate a unit width of pressure sensitive tape from a release coated surface at a controlled angle and speed.

#### **REWINDING**

The operation of winding the webstock from the reel onto a core to produce rolls of the desired width, diameter, and tension.

#### **ROPE STOCK**

A smooth paper made wholly or largely of hemp fiber for tensile strength.

**SATURATION** (impregnation)

Adding materials (saturant) to the backing for improvement of physical properties and resistance to various deleterious environments.

#### **SELF-SEAL**

An adhesive joint that is accomplished by coating both adherend surfaces, and bringing them under pressure; an elastomeric adhesive (cohesive) used on envelope flaps, box closures, etc, whereby the adhesive film will bond only to itself.

#### **SHEAR ADHESION**

The time required, under specified test conditions (surface area, weight load), to slide a standard area of pressure sensitive tape from a standard flat surface in a direction parallel to the surface.

#### **SHEAR STRENGTH AFTER SOLVENT IMMERSION**

The force required to separate a bond by shear force after immersion in a typical varnish solvent under designated conditions.

#### **SINGLE FACED**

A tape to which a pressure sensitive adhesive is applied to only one side of the backing.

#### **SLIP SHEET OR INTERLINER**

See **RELEASE LINER**.

#### **SLIVERING**

When the tape tears or breaks into small pieces, either on unwind or on removal from a surface.

#### **SUBSEQUENT ADHESION**

The force required to remove a unit width of pressure sensitive tape from a standard panel after it has been in contact with a release liner for a given period

of time. This must be compared with the adhesion of the same tape that has not been in contact with the release liner to determine the degree of loss of adhesion.

**SURFACE ENERGY** (surface wetting ability)

The measure of surface tension in dynes. The lower the surface energy of a substrate, the more difficult it becomes for an adhesive or coating to wet out that surface.

**SURFACE TREATING**

Any method of treating a polyolefin so as to alter the surface and render it receptive to inks, paints, lacquers, and adhesives such as chemical, flame, and electronic oxidation.

**TACK**

The property of a pressure sensitive adhesive that allows it to adhere to a surface under very slight pressure. It is determined by the ability of the adhesive to wet quickly the surface it contacts.

**TEAR RESISTANCE**

The force required to propagate a tear in a tape in a given direction after the tear has been initiated.

**TELESCOPING**

A sideways sliding of the tape layers, one over another, such that the roll looks like a funnel or a telescope, usually occurring over a period of time.

**TENSILE STRENGTH** (breaking strength)

The force required to break a unit width of tape by controlled pulling on opposite ends of the piece.

**THICKNESS** (caliper, gauge)

The perpendicular distance from one surface of either a tape, backing, or adhesive to the other, usually expressed in mils, thousandths of an inch, or millimeters. This is usually measured under controlled slight pressure with a special gauge.

**TRANSFER TAPE**

A pressure sensitive adhesive unsupported applied to a two-side release coated liner.

**UNWIND or UNWIND ADHESION**

The force required to remove tape from a roll under prescribed conditions.

**WATER PENETRATION RATE** (WPR)

The weight of water transmitted through a controlled area of tape under a specified time and conditions.

**WATER VAPOR TRANSMISSION** (WVTR)

The weight of water vapor allowed through a controlled area of tape within a specified time period and under controlled conditions.